

Name: \_\_\_\_\_  
 Date: \_\_\_\_\_  
 Track: \_\_\_\_\_

### Track Conditions

Size:  Open  Med.  Tight  
 Traction:  High  Med.  Low  
 Surface:  Smooth  Med.  Bumpy

### Front Suspension

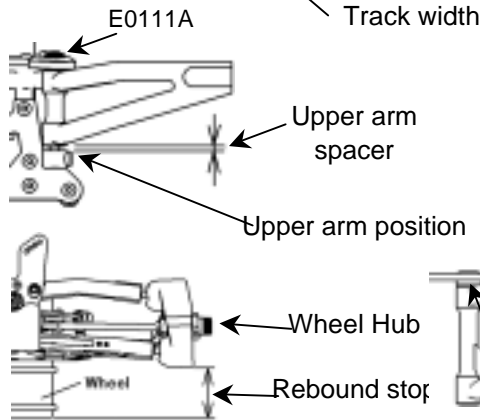
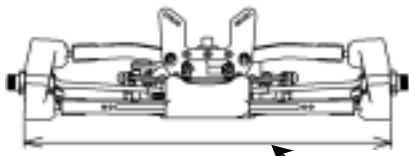

Track width 276 mm  
 Camber angle -2 °  
 Upper arm spacer 1 mm  
 Toe angle **OUT 0.5** °  
 Rebound stop 10 mm  
 Anti-roll bar  $\phi$  2.4 mm  
 Wheel Hub 0 mm  
 Lower arm mount (Kick up) 0 °

Lower arm plate  E0119  
 E0141

Upper arm position (E0111A)    
 E0106A - E0106B (High)  
 E0106C - E0106D (Low)  
 Lower arm spacer 1 mm

### Front Shocks

Piston **Stock**  
 Oil # 400  
 Spring **Stock**  
 Spacer 8 mm  
 Shock position

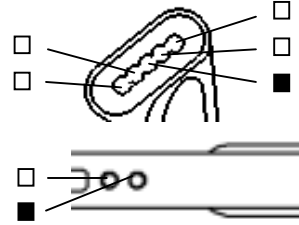

### Steering Ackerman

E0311  
 E0316

### Rear Suspension

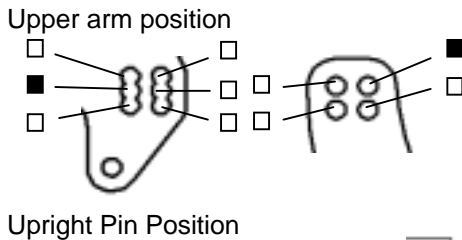
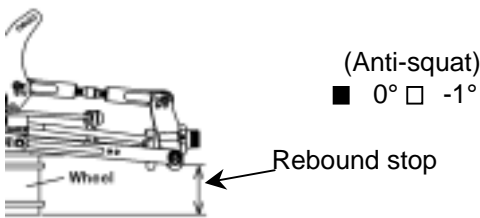

Camber angle -3 °  
 Lower arm mount (Toe angle) 2.75 °  
 Rebound stop 10 mm  
 Anti-roll bar  $\phi$  2.9 mm  
 Anti-squat (E0111C, E0111D)  0°  -1°

Upright  E0110  
 E0126 (Aluminium)

Wheelbase adjustment 2.5 mm  
 Lower arm spacer 0 mm

### Rear Shocks

Piston **Stock**  
 Oil # 400  
 Spring **Stock**  
 Spacer 13 mm  
 Shock position

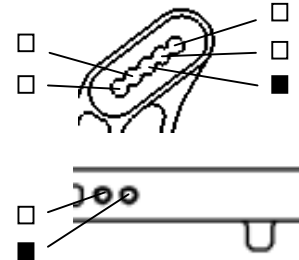

### Wing Position

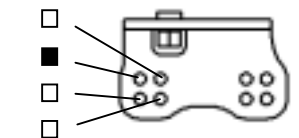

**Engine** Type \_\_\_\_\_  
 Gasket \_\_\_\_\_ mm Reducer  $\phi$  \_\_\_\_\_  
 Plug \_\_\_\_\_ Fuel \_\_\_\_\_  
 Muffler \_\_\_\_\_

**Diff. Oil**  
 Front # 5000 O-Ring - pcs.  Other \_\_\_\_\_  
 Center # 7000 - pcs.  Other \_\_\_\_\_  
 Rear # 1000 - pcs.  Other \_\_\_\_\_

**Tire**  
**Front**  
 Type \_\_\_\_\_  
 Foam \_\_\_\_\_  
**Rear**  
 Type \_\_\_\_\_  
 Foam \_\_\_\_\_

**Clutch**  
 Clutch shoes  Aluminium  Other \_\_\_\_\_  
 Spring 1.0 mm  
 Clutch bell / Spur gear 13T / 46T

**Result**  
 Race time / Lap \_\_\_\_\_  
 Best lap (1Lap) \_\_\_\_\_

**Comments:**  
 \_\_\_\_\_  
 \_\_\_\_\_  
 \_\_\_\_\_  
 \_\_\_\_\_