

2PEKA

INSTRUCTION MANUAL

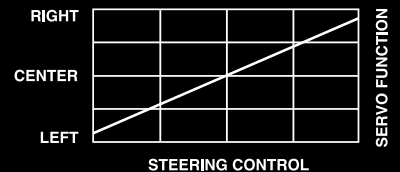

For Car's And Boat's
2 Channel Digital Proportional R/C System



1M23N06101

Futaba[®]

Digital Proportional R/C System

Thank you for purchasing a Futaba 2PEKA.
Before using your 2PEKA, read this manual carefully and use
your R/C set safely.

After reading this manual, store it in a safe place.

APPLICATION, EXPORT, AND RECONSTRUCTION

1. Use this product in models only.

The product described in this manual is subject to regulations of the Ministry of Radio/Telecommunications and is restricted under Japanese law to such purposes.

2. Exportation precautions

(a) When this product is exported from Japan, its use is to be approved by the Radio Law of the country of destination.

(b) Use of this product with other than models may be restricted by Export and Trade Control Regulations. An application for export approval must be submitted.

3. Modification, adjustment, and replacement of parts

Futaba is not responsible for unauthorized modification, adjustment, and replacement of parts of this product.

COMPLIANCE INFORMATION STATEMENT (FOR U.S.A.)

This device, trade name Futaba Corporation of America, model number R123F complies with part 15 of the FCC Rules. Operation is subject to the following two conditions:

- (1) This device may not cause harmful interference, and
- (2) This device must accept any interference received, including interference that may cause undesired operation.

The responsible party of this device compliance is;

Futaba Corporation of America

4 Studebaker

Irvine, CA 92618 USA

TEL (949) 455 - 9888

-No part of this manual may be reproduced in any form without prior permission.

-The contents of this manual are subject to change without prior notice.

-This manual has been carefully written. Please write to Futaba if you feel that any corrections or clarifications should be made.

-Futaba is not responsible for the use of this product.

A WEB SITE FOR THE SERIOUS RACER

Safety Precautions	2
Definition of Symbols	2
Running Preparations Safety Precautions	2
Running Safety Precautions	3
Storage and Disposal Safety Precautions	4
Other Safety Precautions	5
Before Operation	6
System Contents	6
Nomenclature / Handling	7
Assembly / Adjustment	9
Receiver and Servo Connection	9
Assembly Precautions	10
Digital Proportional Adjustment	12
Description of Functions	13
Steering Trim	13
Throttle Trim	13
Servo Reverse	14
Throttle ATV	14
Steering D/R	14
Reference	15
Ratings	15
Troubleshooting	16
Repair Service	17

For your safety as well as that of others. Please read this manual thoroughly prior to installation and operation of your digital proportional R/C system.

Definition of Symbols

The following defines the symbols used in this manual.

Explanation of Symbols

Warning

Indicates a procedure that could result in serious injury or death to the user or other persons if ignored and not performed properly.

Caution

Indicates a procedure that may result in serious injury to the user or other persons, as well as physical damage. If ignored and not performed properly.

Explanation of Graphic Symbols

 Indicates an operation that prompts a warning (including Caution).

 Indicates an operation that must not be performed.

 Indicates an operation that always must be performed.

Running (Sailing) Preparations Safety Precautions

Warning

(When using a Ni-cad battery to power your system)

Charging

-  When using a Ni-cad battery to power your system, always charge and check the battery voltage prior to operation.
Should the battery discharge below the minimum voltage level, control will be lost.

Caution

(When using a Ni-cad battery to power your system)

-  When the charger is not in use, disconnect from the outlet.
To prevent accidents, overheating and short circuits

Running (Sailing) Safety Precautions

Warning

Conduct Tests



Prior to operation always perform a range test. Even one abnormality in the R/C system may cause loss of control. [Range Test Procedure]

Have a friend hold the model, or place on a stand where the wheels or prop can not come in contact with any object. Collapse the transmitter antenna and operate from a distance of about 10 yards. Be sure to check the movement of each servo to make sure they follow the movement of the steering wheel and throttle trigger. If the servos do not follow the commands from the transmitter or any type of interference is detected, Do Not operate the model.



Fully extend the transmitter antenna. If the transmitter antenna is not fully extended range will be reduced and control may be lost.

Prohibited



Do not operate two or more models on the same frequency at the same time. Operation of two or more models on the same frequency at the same time will cause interference and loss of control of both models. AM, FM and PCM are different methods of modulation. Nonetheless the same frequency can not be used at the same point in time, regardless of the signal format.

Do not operate outdoors on rainy days



Never operate in the rain or run through puddles. The transmitter, receiver, batteries and most servos, and speed controls are not waterproof. Contact with any type of moisture or immersion in water or snow will cause damage along with possible loss of control. Should any type of moisture enter any component of the system immediately stop using the R/C system and return to our service center for inspection.

Prohibited



Do not operate when visibility is limited. Should you lose sight of the model a collision or other dangerous situation may occur.

Prohibited



Do not operate near people or roads. Do not operate near high tension power lines or communication broadcasting antennas. Prior to the operation of any model be sure the area you plan to use is safe. Be aware of all objects that may be in the path of your model. Do not operate the model where people or any type of moveable object could stray in the path of your model. Control loss due to interference, component failure, loss of sight or low battery voltage could result in serious injury to yourself and others as well as damage to your model.

Prohibited



Do not operate your R/C system within 1 mile of another site where radio control activity may occur. Interference from other R/C systems will cause loss of control.

Prohibited

Do not operate when you are tired, not feeling well or under the influence of alcohol or drugs.

Your judgement is impaired and could result in a dangerous situation that may cause serious injury to yourself and others.



Before you turn on the power switch on the transmitter, always check to see that the trigger is at the neutral position. Always turn the transmitter on first, then the receiver. When you turn the system off, always turn the receiver off first then the transmitter. This step is very important always follow this procedure.

If this procedure is not followed, injury to yourself and others as well as loss of control could occur.

Adjustment Note

Make all adjustments to the radio control system with engine not running, or the electric motor disconnected.

If the engine is running or the motor is connected while adjustments are made the model may run out of control.



Remove the main battery source from electric powered models when they are not being used.

Should you accidently leave the receiver switch on the model could run out of control.

**Caution****Do not touch**

Do not touch the engine, motor, speed control or any part of the model that will generate heat while running.

Touching hot parts will result in serious burns.

Storage and Disposal Safety Precautions**Warning****(When using a Ni-cad battery to power your system)**

At the end of a days operation store the system with Ni-cad battery discharged. Be sure to recharge the system before it is used again.

You should fully discharge your systems batteries periodicity to prevent a condition called "memory". For example if you only make two run in a day or you regularly use a small amount of the batteries capacity, the memory effect can reduce the actual capacity even if the battery is charged for the recommended amount of time.

Prohibited

Do not throw a Ni-cad battery into a fire. Do not disassemble or attempt to repair a Ni-cad battery pack.

Overheating, damage and acid leakage may lead to burns, loss of eye sight as well as numerous other types of injuries. The electrolyte in Ni-cad batteries is a strong alkali. Should you get even the smallest amount of the electrolyte in your eyes, Do Not rub, wash immediately with water, seek medical attention at once. The electrolyte can cause blindness. If electrolyte comes in contact with your skin or clothes, wash with water immediately.

Caution

Prohibited



Do not store your R/C system where it will be exposed to the following conditions.

- Extreme heat or coldness
- Exposed to direct sunlight
- Where humidity is high
- Where vibration is prevalent
- Where dust is prevalent
- Where there is steam and condensation
- Where the system would be exposed to engine exhaust

Storing your R/C system under adverse conditions could cause deformation and numerous other problems with operation.

(When using a Ni-cad battery to power your system)

Caution



When disposing Ni-cad batteries, cover any exposed contacts with some type of insulation to prevent short circuit.

Improper disposal could cause fire.

*Special Note!

Some states require special handling when Ni-cad batteries are disposed. Contact the State Agency responsible for recycling hazardous waste for the procedures in your state.

Other Safety Precautions

Caution



When operating two or more models at the same time, have a third person act as a spotter. They will be in charge of safety and you should follow their instructions.



Beginners should receive instructions regarding safety and operation from an experienced modeler.

Use genuine Futaba parts only.



Always use only genuine Futaba receiver, servos, electronic speed controls along with other optional parts and components.

Futaba will not be held responsible for damages caused by other than genuine Futaba parts and components. Use only genuine Futaba parts and components listed in the instruction manual and catalog.

(When using a Ni-cad battery to power your system)

Prohibited



Do not short circuit the Ni-cad battery terminals.

Short circuiting the terminals will lead to sparks and overheating and could cause a fire and burns as well.

A WEB SITE FOR THE SERIOUS RAGER

System Contents

After opening the container, check the contents for the following items. the contents will vary with the system purchased.

	System with 2 Servos	System with 1 MC210CB and 1 Servo	System with 1 MC310CB and 1 Servo
Transmitter	T2PEKA (x1)		
Receiver	R123F (x1)		
Servo	S3003 (x2)	S3003 (x1)	
E.S.C.		MC210CB (x1)	MC310CB (x1)
Switch	SSW-GS (x1)		
Battery Holder	R2-BSS-B (x1)		
Miscellaneous	Servo mounting hardware and servo horns		
		Mini Screwdriver	

Before Operation

Should any item be missing or you are uncertain of the contents of the system, please contact the dealer where the unit was purchased.

Receiver R123F

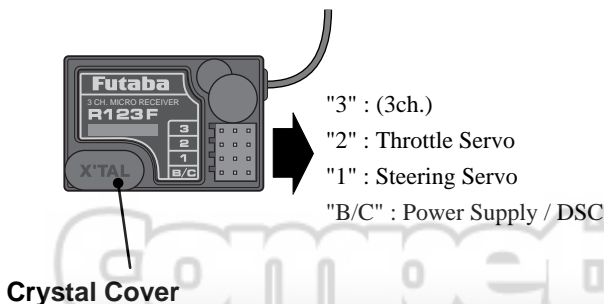

Servo S3003

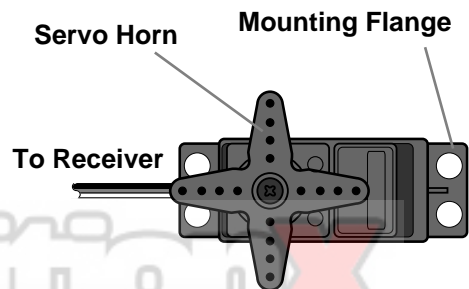

Nomenclature / Handling

Transmitter T2PEKA

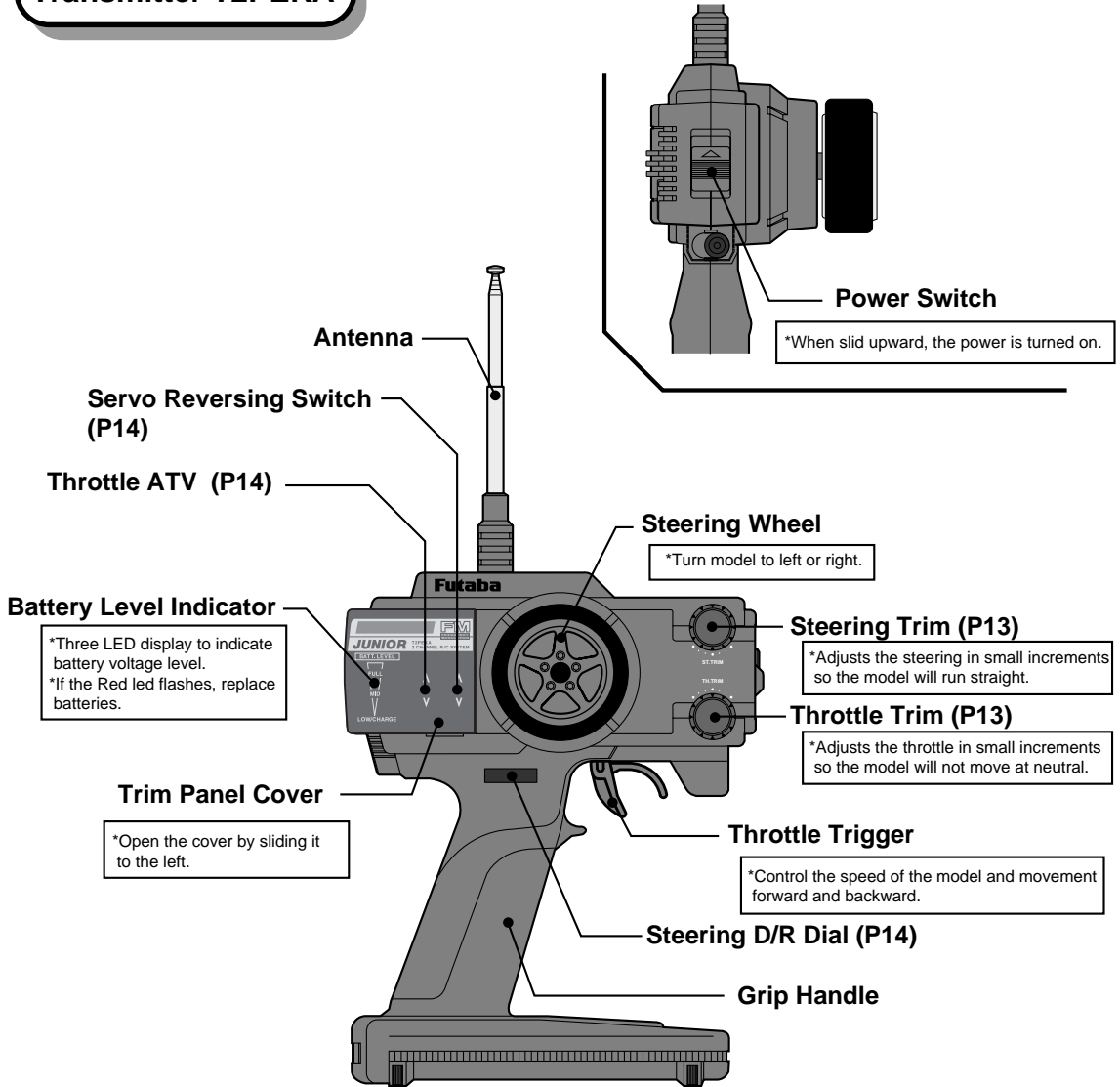

Before Operation

E.S.C.

MC210CB
MC310CB

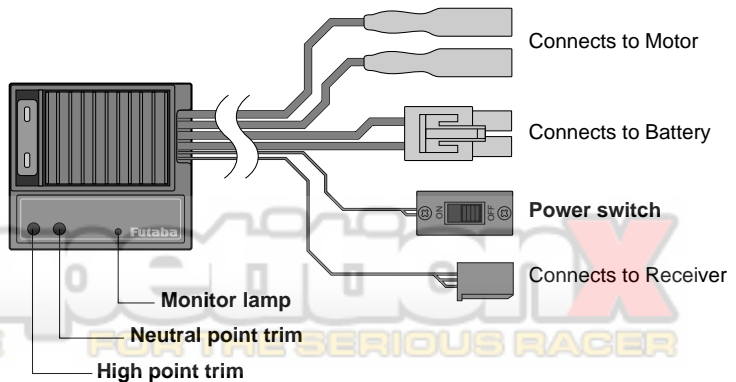

COMPTON
A WEB SITE FOR THE SERIOUS RACER

Battery Replacement

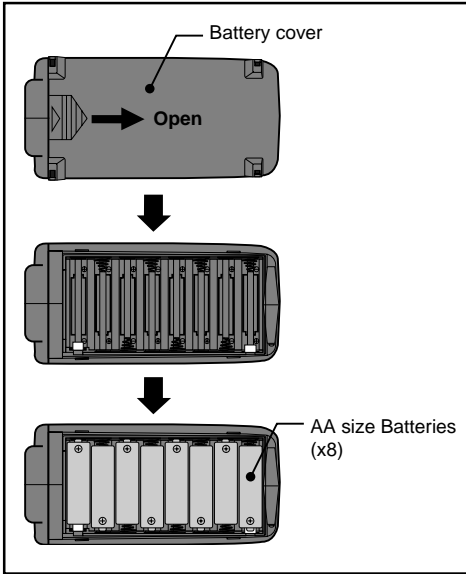

Handling Procedure For Batteries (8 AA Size Batteries)

(Battery Replacement Method)

- 1 Remove the batteries from the transmitter by sliding the cover in the direction of the arrow in the figure.
- 2 Remove the used batteries.
- 3 Load the new AA size batteries . Pay very close attention to the polarity markings and reinsert accordingly.
- 4 Slide the battery cover back onto the case.

(Check)

Turn the power switch on the transmitter to the ON position. Check to see if the three LEDs light. If the LEDs fail to light, check the batteries for insufficient contact in the case or incorrect battery polarity.

Caution

Always be sure you reinsert the batteries in the correct polarity order.

If the batteries are loaded incorrectly , the transmitter may be damaged.

When the transmitter will not be used for any short or long period of time, always remove the batteries.

If the batteries do happen to leak , clean the battery case and contacts thoroughly. Make sure the contacts are free of corrosion.

(Battery Disposal)

Some states require special handling when any type of battery is disposed. Contact the State Agency responsible for recycling hazardous waste for procedures in your area.

(Battery Alarm Display)

When the Green battery level indicator (LED) goes off and the Red LED flashes, change the batteries immediately.

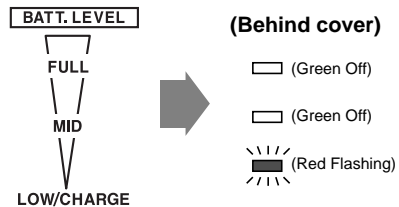

Receiver and Servo Connection

As you connect the receiver, servo's and other components, do so in accordance with the "Assembly Precautions" listed on the next page.

Connections when a E.S.C. MC210CB or MC310CB are used.

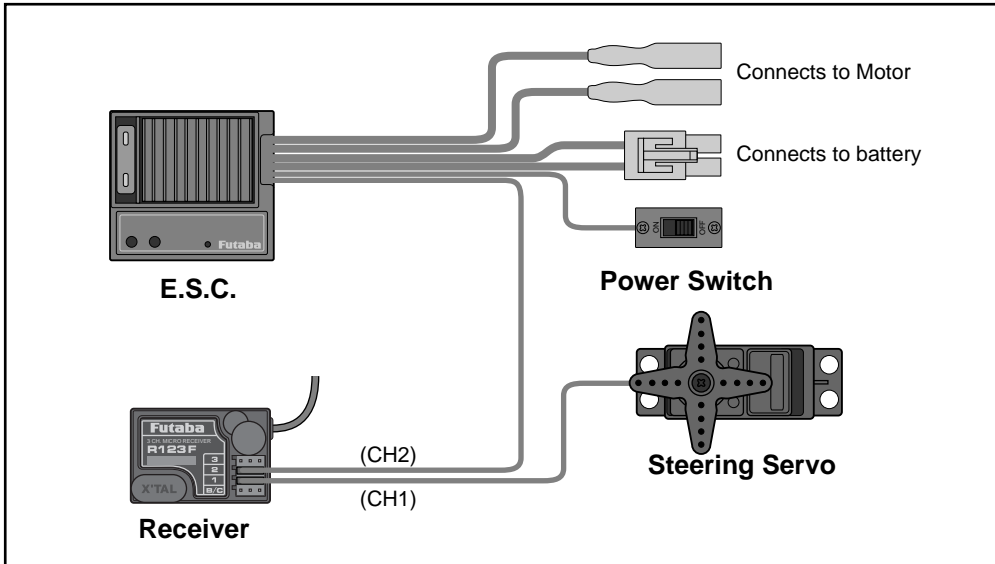

Gas Powered Model

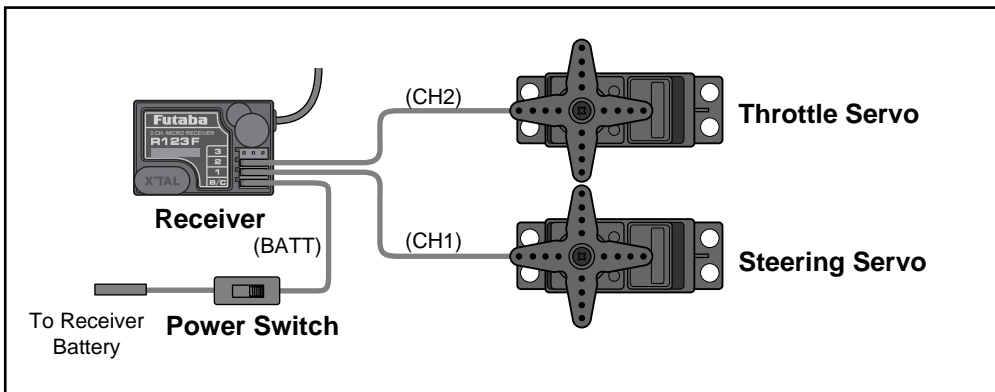

Assembly Precautions

Warning

Check



Check the receiver, servos, and battery connectors, to be sure they are firmly connected.

If a connector is not fully inserted, vibration may cause the connector to work loose while the model is operating. This will result in loss of control.

Check



Operate each servo horn over its full stroke and check to see that the linkage does not bind or is not too loose.

Excessive force applied to the servo horn by binding or poor installation may lead to servo problems and cause result in loss of control.

Prohibited



The receiver antenna may seem long. Do not cut or alter from the original length.

If the receiver antenna length is altered, the receiver will be adversely effected. The receiver will become considerably more susceptible to interference and high frequency noise which will result in loss of range and control.

Installation Note



(Electric Car's and Boat's)

Isolate the receiver from vibration by attaching to the chassis or mounting plate with thick double sided tape.

(Gas Powered Car's and Boat's)

Isolate the receiver from vibration by wrapping it in foam rubber or similar type cushioning material. Protect the unit from water damage by placing it in a plastic bag or waterproof radio box.

The receiver contains precision electronic parts. These parts are vulnerable to vibration and shock. Any contact with moisture (water or condensation) may cause receiver malfunction and loss of control.

Installation Note



Keep all devises that may omit high frequency noise, such as motor's, batteries, and wiring that handle heavy current loads, at least 1/2 inch away from the receiver and receiver antenna.

High frequency noise will cause a decrease in operating range and could cause loss of control.

Use genuine Futaba parts only.



Use only genuine Futaba crystal set's as specified in this instruction manual.

The use of other than Futaba crystal set's will result in decrease of range as well as loss of control. There are separate crystal's for the Transmitter and Receiver, there are also crystal set's for AM, FM and Dual Conversion FM. Use only single conversion AM crystal set's with this system.

Changing crystals in 72-75 MHz transmitter is illegal, however 27 MHz is allowable. (For U.S.A.)

CompetitionX
A WEB SITE FOR THE SERIOUS RAGER



Install electronic speed control heat sinks as well as other components that conduct electricity so they can not come in contact with aluminum, carbon fiber or other materials that conduct electricity.

If for example the speed control came loose while the model was running and touched an aluminum chassis a short circuit may occur that would cause irreparable damage to the system as well as loss of control.

Installation Note



Noise suppression capacitors should be installed on almost all motors.

If the proper capacitors are not installed, high frequency noise will reduce range and cause loss of control along with various other problems.

Installation Note



Inspect all linkage installations and any point where metal could come in contact with other metal parts. Make sure these parts do not touch other metal parts under vibration.

Should a linkage or other metal parts come in contact with other metal parts under vibration the high frequency noise generated by this contact will cause interference and possible loss of control.

Caution

Disassembly Prohibited



Do Not disassemble any part of this system that is not specified in the instruction manual.

Futaba will not be responsible for any damage due to improper disassembly of any part of the radio control system.

Digital Proportional Adjustment

*When making these settings adjustments , do so with the motor disconnected or the engine not running.

Servo Horn Installation Instructions.

- 1 Connect the receiver, servos, and other components and then turn on the power switches to transmitter and receiver.
- 2 Be sure the Steering trim and Throttle trim on the transmitter are at their neutral position .
- 3 At this time install the servo horn in the manner described in the instruction manual provided with the model this system will be used in.

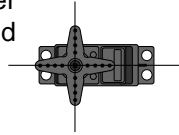

Both servos will move to the neutral position.

Reversing The Servo Operation Direction

Should the servo operate in the opposite direction required for your application, reverse the rotation with the reversing switch.

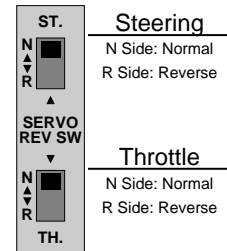

(Reversing Switches)

E.S.C. MC210CB / MC310CB

(Preparations)

- 1 Set the servo reversing switch on the transmitter to normal side.
- 2 Turn the high point trim fully clockwise.

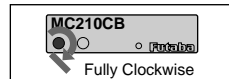

(Neutral Adjustment)

- 3 Have the throttle trigger at neutral.
- 4 Set the neutral trim to the point where the monitor lamp goes off.

*The point where the monitor lamp changes from a rapid flashing light to off is the neutral point.

* Adjust the Amp with the mini screwdriver supplied with this system.

*(forcing the adjustment trims past their stop will cause internal damage to the speed control.)

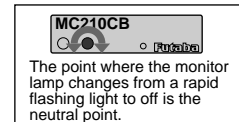

(High Point Adjustment)

- 5 Hold the throttle trigger in the position just before full throttle.
- 6 Set the high point trim at the point where the monitor lamp changes from a flashing light to steady light.

*The point where the monitor lamp changes from a rapid flashing state to a steady light is the high point.

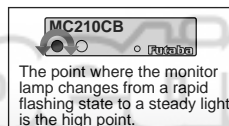

(Monitor Lamp Display)

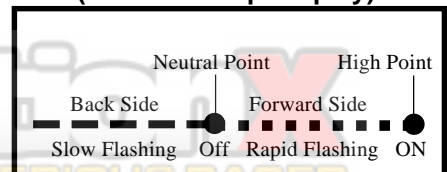

Steering Trim

Steering neutral adjustments can be made by moving the Steering trim knob to the left or right.

Racers Tip

When you install a servo always check to be sure the servo is at its neutral position. Adjust the servo horn hole position and linkage so both are parallel. When a servo saver is used place it as close to center position as possible. Be sure the steering trim on the transmitter is at the neutral position.

Trim Operation and Maximum Travel

Changing the trim can effect the overall settings, when adjustments are made with the trims recheck your installation for maximum servo travel. (Steering ATV right side and left side).

When Trim usage is extreme

If it takes most of your trim movement to get a servo to the neutral position, reposition the servo horn or servo saver on the servo and inspect your linkage installation.

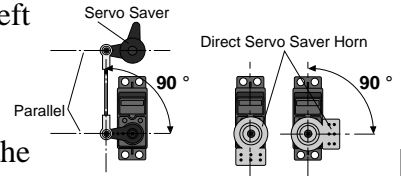
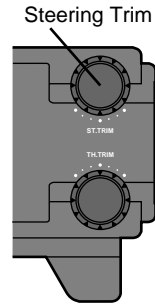

Throttle Trim

Throttle neutral adjustments can be made moving the throttle trim to the left or right.

Racers Tip

When using a electronic speed control set the throttle trim to neutral and make adjustments to the speed control. On a gas powered model set the trim to neutral and adjust the linkage to the point where the carburetor is fully closed in accordance with the engine instruction manual.

Trim Operation and Travel

Trim adjustments will effect the overall servo travel, check the brake side (backward) movement when changes are made.

When trim movement is extreme

If you use most of the trim movement to get the servo to the neutral position, recenter the servo horn closer to the neutral position and inspect your throttle linkage.

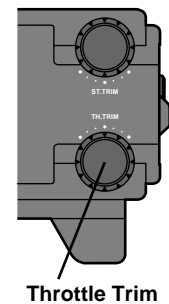

Carburetor Fully Closed

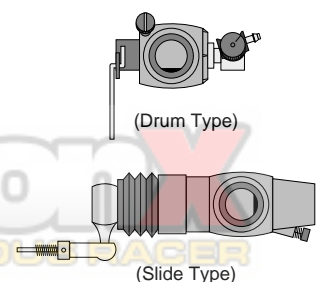

Servo Reverse

This function reverses the rotation direction of the Steering and Throttle servos.

When the trim position deviates from the center, the deviation will be on the opposite side when the servo is reversed.

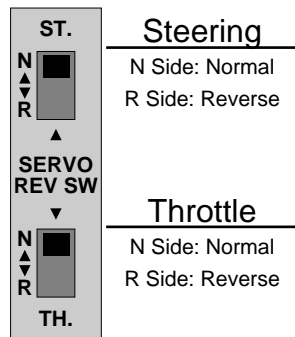

(Reversing Switches)

Throttle ATV

This function is used to adjust the forward and brake side servo travel. Each direction can be adjusted independent of each other. Use this feature to set the throttle servo travel.

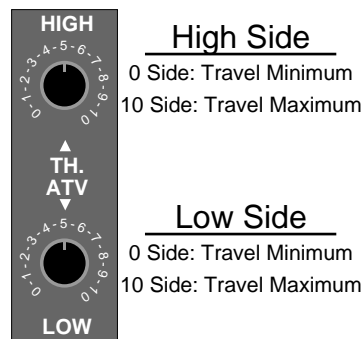

(Throttle ATV)

Warning

Be sure that your throttle linkage does not apply excessive force to the servo.

If your linkage installation causes an unreasonable amount of force to be applied to the servo. The servo may be damaged and result in loss of control.

Description of Functions

Steering D/R

Use this function to adjust the steering travel of your model. If the model understeers (push) while cornering, add steering by turning the dial clockwise.

When the model oversteers (loose), take away steering by turning the dial counterclockwise.

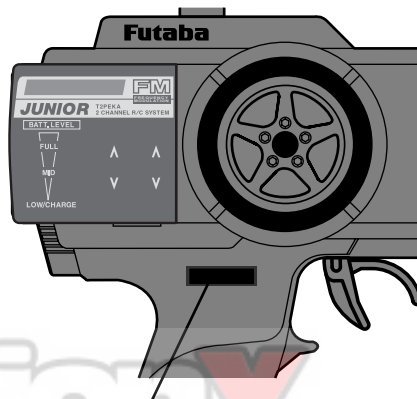

Steering D/R
Travel Minimum ↔ Travel Maximum

*Specifications and ratings are subject to change without prior notice.

Ratings

Transmitter *T2PEKA*

(2 channels, FM transmitter)

Transmitting frequency:

27, 29, 40, 41, 72 or 75 MHz

Modulation method: FM

Power requirement:

12V (penlight battery X 8)

Current drain: 250mA

Servo *S3003*

(standard servo)

Power requirement:

4.8V or 6V (common with receiver)

Current drain: 8mA (at 6V / Idle)

Output torque: 3.2kg-cm (at 4.8V)

Operating speed: 0.23sec/60 degree (at 4.8V)

Size: 40.4x19.8x36mm

Weight: 37.2g

Receiver *R123F*

(3 channels, FM receiver)

Receiving frequency:

27, 29, 40, 41, 72 or 75 MHz

Intermediate frequency: 455kHz

Power requirement: 4.8 - 8.4V

Current drain: 10mA (at 4.8V / No signal)

Size: 25.6X37.6X15.5mm

Weight: 15.8g

E.S.C. *MC210CB / MC310CB*

(Electronic speed control)

Voltage drop (at 20A):

Approximately 0.52V (210)

Approximately 0.41V (310)

(Between input and output)

Maximum current: 30A (210) , 35A (310)

(Fuse capacity)

Power requirement: 7.2 to 8.4V

Regulator output: 6V/3A Max(210)

6V/1A Max at 7.2V(310)

6V/0.5A Max at 8.4V(310)

Size: 45.5X41.5X26.0mm

Weight: 72.5g (210), 78g (310)

Troubleshooting

If your digital proportional R/C set does not operate, its range is short, it intermittently stops operating, or it operates erroneously, take the action shown in the table below. If this does not correct the trouble, please contact a Futaba dealer.

Check point	Check item	Action
Transmitter/receiver battery	Dead battery. Incorrect loading. Faulty contact connection. Dirty contacts.	Replace the battery. Charge the nicd battery. Reload the batteries in the correct polarity. If the contact spring is deformed, correct it. Wipe with a dry cloth.
Transmitter antenna	Loose. Not extended to full length.	Screw in. Extend fully.
Crystal	Disconnected. Wrong band. Different from specification.	Push in. Match transmitter/receiver band. Replace with specified crystal.
Connector connection	Incorrect wiring. Disconnection.	Reinsert. Push in.
Receiver antenna	Close to other wiring. Not cut? Not bundled?	Separate from other wiring. Request repair. Install in accordance with instruction manual.
Servo linkage	Binding or looseness	Adjust at the model side.
Motor	Noise countermeasures.	Install a noise absorbing capacitor.

CompetitionX
A WEB SITE FOR THE SERIOUS RACER