

**SPEKTRUM**<sup>®</sup>  
3-Channel, 4-Model Memory  
DSM<sup>®</sup> Racing System

© 2009 Horizon Hobby, Inc.  
4105 Fieldstone Road  
Champaign, Illinois 61822 USA  
(877) 504-0233  
**horizonhobby.com**

Horizon Hobby UK  
Units 1-4 Ployters Rd  
Staple Tye  
Harlow, Essex  
CM18 7NS  
United Kingdom

Horizon Hobby Deutschland GmbH  
Hamburger Strasse 10  
25335 Elmshorn  
Germany

DSM and DSM2 are trademarks or registered trademarks of Horizon Hobby, Inc. The Spektrum trademark is used with permission of Bachmann Industries, Inc. Spektrum radios and accessories are exclusively available from Horizon Hobby, Inc.

**US patent number 7,391,320. Other patents pending..**



**Competition X**  
A WEB SITE FOR THE SERIOUS RACER

## Table of Contents

Introduction.....	3
DX3.0 Quick Start Setup.....	3
DX3.0 Quick Start Setup (continued).....	4
DX3.0 Quick Start Setup (continued).....	5
Direct Trim Access .....	5
DX3.0 with Digital Spectrum Modulation.....	6
Binding .....	6
Binding (continued) .....	7
Antenna.....	7
Receiver Power System Requirements .....	8
Power System Test Guidelines .....	8
Typical Range.....	8
System Features.....	9
Tips on Using Spektrum 2.4GHz .....	9
RC Safety Precautions.....	10
Steering Tension Adjustment.....	10
Control Identification and Location .....	11
Receiver Compatibility .....	12
Receiver Connections and Installation.....	12
Charging Jack.....	13
Key Input and Display .....	13
Display Screens .....	14
Accessing the System Mode .....	15
Model Select.....	16
Model Name Entry .....	16
Frame Rate.....	17
Auxiliary Channel 3 Function Select .....	17
Auxiliary Channel 3 Function Select (continued) .....	18
Grip Button C Function Select.....	18
Grip Button C Function Select (continued).....	19
Data Reset.....	20
Copy Model Data .....	20
RF Mode .....	21
Accessing the Function Mode.....	22
Mode Key.....	22
Throttle Deadband.....	23
Exponential .....	24
Endpoint Adjustment.....	25
Programmable Mixing.....	26
Lap Timer .....	27
Sub-Trim.....	28
Servo Reversing.....	28
Accessing the Direct Trim Mode.....	29
Steering Trim (STC) .....	30
Throttle Trim (THC).....	31
Grip Lever B: Steering Dual Rate Trim Adjustment STG.....	32
Grip Lever A: Brake Endpoint Adjustment BRK/Auxiliary Channel 3 Access.....	33
Auxiliary Channel 3 Access (Fuel Mixture) .....	34
Auxiliary Channel 3 (Transmission Shift Selector) .....	34
Warranty and Service Information .....	35
FCC Information.....	38
CE Compliance Information for the European Union .....	39

## Introduction

Thank you for purchasing Spektrum's DX3.0 radio system. The DX3.0 is designed to provide RC racers with a bulletproof 2.4GHz spread spectrum radio link. With the DX3.0 DSM system you'll no longer have to wait for a frequency clip, worry about radio interference from noisy motors or ESCs or be concerned that someone may turn on a radio on your channel causing interference. In addition, the DX3.0's programming is user-friendly and offers the most important features and functions that racers demand. It's important that you carefully read this manual before attempting to operate your DX3.0 system.

For those who would like to get out to the track quickly with just the basic radio setup, please refer to the Quick Start section that follows.

## DX3.0 Quick Start Setup

Included in this manual are in-depth instructions detailing all the steps and procedures needed to program each of the DX3.0's functions. For those racers who want to get to the track fast, we have provided the Quick Start section below. Quick Start covers the basic programming information necessary to get you racing right away.

Later, when you want to learn more about the specific functions of the DX3.0, refer to the appropriate page(s) in this manual for more detailed programming information.

**Note:** If braking adjustment via Grip Lever A is required, refer to the third channel system setup mode (page 32) for instructions.

## Binding

It's necessary to program the receiver to a specific transmitter so that the receiver will only recognize that transmitter, ignoring signals from any other sources. If the receiver is not bound to a transmitter, the system will not operate. Also, during the binding process, the servo failsafe positions are set.

1. Make sure the transmitter and receiver are turned off.
2. With the receiver off, insert the bind plug into the BIND port on the receiver.
3. Power the receiver through any port. The green LED will flash continuously, indicating the receiver is in bind mode.
4. Hold down on the SCROLL and CHANNEL buttons while turning on the transmitter. To enter System Mode, press the SCROLL button until "BND" appears on the screen.
5. With the steering wheel and the throttle trigger in their desired failsafe positions, press the INCREASE and DECREASE buttons at the same time to enter bind mode. "BND" will flash when in bind mode.
6. After several seconds the LED on the receiver will quit flashing and remain solid, indicating that the binding process was successful. Once binding is complete, the system will automatically connect.
7. Once the bind process is complete and before power is cycled on the receiver, remove the bind plug from the receiver and store it in a convenient place. Failure to remove the bind plug will result in the receiver going back into bind mode.

**Note:** See page 6–7 for a detailed description of the binding process.

## DX3.0 Quick Start Setup (continued)

### Servo Reversing

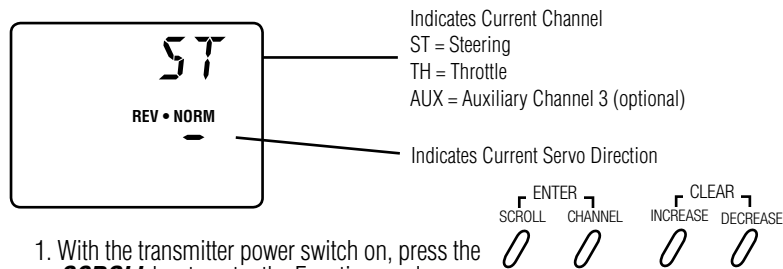

1. With the transmitter power switch on, press the **SCROLL** key to enter the Function mode.
2. Press the **SCROLL** key until REV.NORM appears on the screen. The "ST" indicates the steering servo reversing screen.
3. Press the **INCREASE** or **DECREASE** key to move the cursor to the desired servo direction (REV.NORM).
4. Press the **CHANNEL** key once to access the throttle servo reversing screen.
5. To select the direction of the throttle servo, repeat Step 3 above.
6. Repeat Steps 2 and 3 to adjust Auxiliary Channel 3 if needed.

### Endpoint (Travel) Adjustment

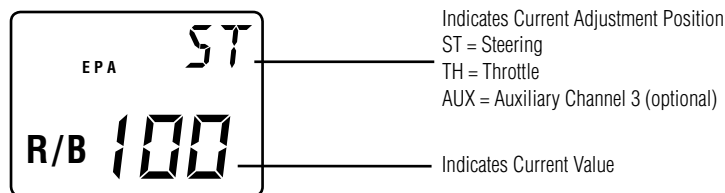

L/F = Left/Forward  
R/B = Right/Brake

1. From the Servo Reverse function, press the **SCROLL** key once to access the Endpoint (Travel) Adjustment function (the EPA screen with "ST" will appear).

### Steering Adjustment

2. Rotate the steering wheel in the desired direction (left or right) to be adjusted.
3. Press the **INCREASE** or **DECREASE** key to select the desired travel value.

### Throttle Adjustment

4. Press the **CHANNEL** key once. TH will appear on the screen.
5. Pull the trigger for forward or push the trigger for brake adjustment.
6. Press the **INCREASE** or **DECREASE** key to select the desired travel value.

### Auxiliary Channel 3 Adjustment

**Note:** AUX will need to be programmed for either Grip Lever A or Grip Button C. See page 17.

- If a third channel is not required, proceed to Step 10.
7. Press the **CHANNEL** key once. AUX will appear on the screen.
8. Toggle the appropriate lever/button to select the desired endpoint.
9. Press the **INCREASE** or **DECREASE** key to select the desired travel value.
10. Press the **SCROLL** and **CHANNEL** keys at the same time to exit the function mode.

## DX3.0 Quick Start Setup (continued) Direct Trim Access

### Servo Trim Adjustment

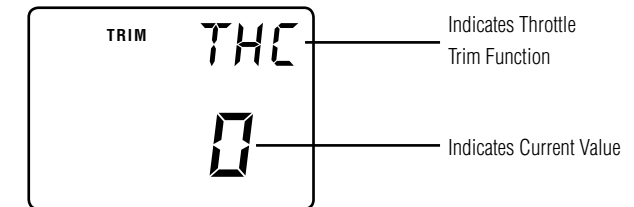
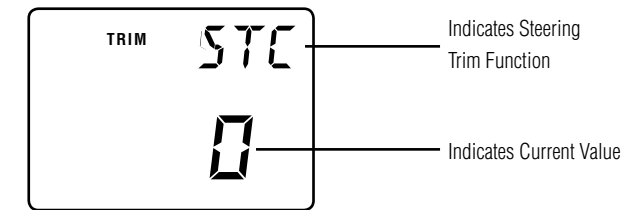

### Steering

1. With the transmitter power switch on, move the digital steering trim lever in the desired position to be adjusted. The steering trim value screen will appear automatically.

### Throttle

2. With the transmitter power switch on, move the digital throttle trim lever in the desired position to be adjusted. The throttle trim value screen will appear automatically.

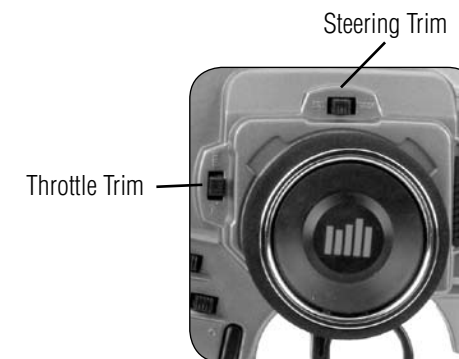

## DX3.0 with Digital Spectrum Modulation

The DSM® system operates in the 2.4GHz band (that's 2400MHz). This high frequency offers a significant advantage, as it's well out of the range of model-generated radio interference (like motor and ESC noise). All the complex issues that now exist using 27 and 75MHz radios with model-generated interfering noise are eliminated with this system. The DSM system uses Direct Sequencing Spread Spectrum modulation to generate a wide signal on a single frequency. The FCC requires that these systems be "smart"—incorporating collision avoidance such that when a system is turned on, it scans the 2.4GHz band and selects a channel that is not being used, then begins transmitting on that unused channel. Seventy-nine channels are available and the odds of one DSS spread spectrum system interfering with another are astronomically remote.

## Binding

During the first installation, the receiver(s) must be bound to the transmitter. Binding is necessary to program the receiver(s) to distinguish its corresponding transmitter from others. Also failsafe positions are transferred from the transmitter to the receiver during binding.

It is necessary to bind the receiver to the transmitter during the first installation, and is recommended when the receiver is moved from one vehicle to another. Receivers can be re-bound to the same transmitter or to other transmitters an infinite number of times. Also multiple receivers can be bound to a single transmitter, which is common when using one transmitter to operate several models.

Only bound receivers and transmitters can connect. During power-up, the transmitter scans for a free channel while the receiver scans for its bound transmitter. When control is achieved, the LED on the receiver remains on continuously.

In the unlikely event that the link is lost during use, the receiver will drive the servos to their failsafe positions that were preset during the binding process. If the receiver is turned on prior to turning on the transmitter, the receiver will enter the failsafe mode, driving the servos to their preset failsafe position. When the transmitter is turned on, normal control is resumed.

### To bind the receiver to the transmitter

1. Make sure the transmitter and receiver are turned off.

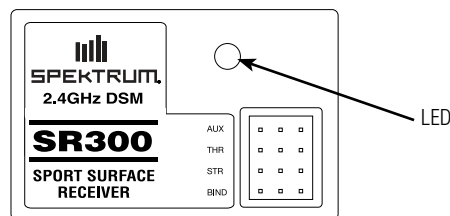

2. With the receiver off, insert the bind plug into the BIND port on the receiver.
3. Power the receiver through any port. The green LED will flash continuously, indicating the receiver is in bind mode.

## Binding (continued)

4. Hold down on the SCROLL and CHANNEL buttons while turning on the transmitter. To enter System Mode, press the SCROLL button until "BND" appears on the screen.



5. With the steering wheel and the throttle trigger in their desired failsafe positions, press the INCREASE and DECREASE buttons at the same time to enter bind mode. "BND" will flash when in bind mode.
6. After several seconds the LED on the receiver will quit flashing and remain solid, indicating that the binding process was successful. Once binding is complete, the system will automatically connect.
7. Once the bind process is complete and before power is cycled on the receiver, remove the bind plug from the receiver and store it in a convenient place. Failure to remove the bind plug will result in the receiver going back into bind mode.

## Antenna

At 3.6 inches in length, the receiver antenna is significantly shorter than conventional antennas. Like all antennas, it's important to mount the antenna vertically. In most cases the antenna can be mounted inside the body with no loss of range. Mount the receiver antenna as recommended by the manufacturer of the vehicle, however, it may be necessary to trim the plastic antenna tube (included with your vehicle).

## Receiver Power System Requirements

Inadequate or intermittent power to the receiver that is unable to provide the necessary minimum voltage during operation is the number one cause of control failures with Spektrum systems. Some of the power system components that affect the ability to properly deliver adequate power include:

- Receiver battery pack (number of cells, battery construction quality, connector and state of charge)
- The ESC's capability to deliver current to the receiver and servos in electric vehicles
- The switch harness, battery leads, servo leads, regulators etc.

All Spektrum receivers have a minimum operational voltage of 3.5 volts. If the voltage drops below 3.5 volts, the system will cease control until power is regained.

## Power System Test Guidelines

If a questionable power system is being used (e.g. small or old battery, ESC that may not have a BEC that will support the servo's current draw, etc.), it is recommended that a voltmeter be used to perform the following test.

Plug the voltmeter into an open channel port in the receiver and with the system on, load the servos (apply pressure with your hand) while monitoring the voltage at the receiver. The voltage should remain above 4.8 volts even when all servos are loaded. For gas vehicles, tap and twist the receiver battery pack while watching the voltmeter. Some battery packs have poorly welded tabs that give only intermittent power. Such a defect will show up during shock and vibration, so this test will verify that the battery construction is good.

## Typical Range

Your system's range can vary greatly due to your installation and the environment. In most cases you should be able to have full control of your vehicle to the limits of sight (about 300 ft with a 1/10-scale car). If range issues exist your installation can be optimized by extending the receiver's antenna as vertically as possible locating it as high in the vehicle as practical and also by routing the antenna away from any onboard electronics.

## System Features

- DSM 2.4GHz Spread Spectrum Modulation
- Now compatible with DSM2 and Marine surface receivers, in addition to DSM surface receivers
- Three channels
- Easy-to-read LCD graphics display
- Four-model memory
- Three-character model name entry
- Electronic digital trim levers for throttle and steering
- Two assignable electronic grip switches (Lever A and Button C)
- Third channel accessible through Grip Lever A or Grip Button C
- Direct display trim function
- Sub-trim
- Steering rate adjustment
- Independent steering endpoint adjustments
- Brake/throttle endpoint adjustment
- Low battery alarm
- Charge jack receptacle (rechargeable batteries not included; order JRPB958)

## Tips on Using Spektrum 2.4GHz

While your DSM equipped 2.4GHz system is intuitive to operate, functioning nearly identically to 27 and 75MHz systems, following are a few common questions from customers.

1. Q: Which do I turn on first, the transmitter or the receiver?

A: If the receiver is turned on first—all servos will be driven to their preset failsafe positions set during binding. When the transmitter is then turned on the transmitter scans the 2.4GHz band and acquires an open channel. Then the receiver that was previously bound to the transmitter scans the band and finds the GUID (Globally Unique Identifier code) stored during binding. The system then connects and operates normally.

If the transmitter is turned on first—the transmitter scans the 2.4GHz band and acquires an open channel. When the receiver is then turned on all servos are driven to their preset failsafe positions for a short period of time (the time it takes to connect). The receiver scans the 2.4GHz band looking for the previously stored GUID and when it locates the specific GUID code and confirms uncorrupted repeatable packet information, the system connects and normal operation takes place. Typically this takes 2 to 6 seconds.

2. Q: Sometimes the system takes longer to connect and sometimes it doesn't connect at all.

A: In order for the system to connect (after the receiver is bound) the receiver must receive a large number of consecutive uninterrupted perfect packets from the transmitter. This process is purposely critical of the environment ensuring that it's safe to operate when the system does connect. If the transmitter is too close to the receiver (less than 4 ft.) or if the transmitter is located near metal objects (metal TX case, the bed of a truck, the top of a metal work bench, etc.) connection will take longer and in some cases connection will not occur as the system is receiving reflected 2.4GHz energy from itself and is interpreting this as unfriendly noise. Moving the system away from metal objects or moving the transmitter away from the receiver and powering the system again will cause a connection to occur. This only happens during the initial connection. Once connected the system is locked in and should a loss of signal occur (failsafe) the system connects immediately (4ms) when signal is regained.

## RC Safety Precautions

3. Q: I've heard that the DSM system is less tolerant of low voltage. Is that correct?

A: All DSM receivers have an operational voltage range of 3.5 to 9.6 volts. With most systems this is not a problem as in fact most servos cease to operate at around 3.8 volts. When using multiple high-current draw servos with a single or inadequate battery/power source, heavy momentary loads can cause the voltage to dip below this 3.5-volt threshold thus causing the entire system (servos and receiver) to brown out.

4. Q: Sometimes my receiver loses its bind and won't connect requiring rebinding. What happens if the bind is lost during use?

A: The receiver will never lose its bind unless it's instructed to. It's important to understand that during the binding process the receiver not only learns the GUID (code) of the transmitter but the transmitter learns and stores the type of receiver that it's bound to. If the transmitter is placed into bind mode, the transmitter looks for the binding protocol signal from a receiver. If no signal is present, the transmitter no longer has the correct information to connect to a specific receiver and in essence the transmitter has been "unbound" from the receiver.

For safe and reliable performance of your RC model, please carefully read and follow these guidelines.

1. Radio control models are not toys. They are capable of inflicting serious injury to people and property. Use caution at all times when operating your model.
2. You are responsible for the safe operation of your RC model. You must properly install, test and operate your model with a clear sense of that responsibility. Do not take risks that might endanger yourself or others.
3. Running an RC car in the streets is very dangerous to both drivers and models. Avoid running your model in areas occupied by full-size automobiles. To locate areas where you can safely operate your model, you should contact your local hobby shop for RC tracks or clubs in your area.
4. When running an RC boat, keep it away from any swimmers, full-size boats, or wildlife. Also, watch carefully for fishing lines that can get tangled in the propeller.
5. If at any time while operating your RC model you observe abnormal model functioning, end your operation immediately. Do not operate your model again until you are certain the problem has been corrected.

**CAUTION:** Control of your model is impossible without sufficient voltage for the transmitter and receiver. A weak transmitter battery will decrease your range of operation and a weak receiver battery will slow servo movement and decrease your range of operation. Check your receiver pack voltage often to avoid losing control of your model.

## Steering Tension Adjustment

Steering tension is adjustable via the recessed screw located beneath the steering wheel (see page 11 for exact location). Turning the screw clockwise increases the steering tension.

## Control Identification and Location



\* To remove the Battery Cover, press down on the ridges and push the cover in the direction of the arrow. Remove the battery cover and install 8 AA batteries in the direction as molded into the battery holder. If the transmitter voltage fails to register, check for correct battery installation and review voltage again.

## Receiver Compatibility

The DX3.0 features DSM technology and is compatible with Spektrum DSM and DSM2 surface receivers and the marine receiver.

### COMPATIBLE SPEKTRUM RECEIVERS

The DX3.0 is compatible with the following receivers.

**Note:** The DX3.0 operates in 11ms frame rate when in fast mode and 16.5ms frame rate when in normal mode. See page 17 for more information about frame rates.

**DSM:** SR300 - 3-channel Sport - SPMSR300  
 SR3000 - 3-channel Standard - SPM1200  
 SR3001 - 3-channel Pro - SPM1205  
 SR3300T - 3-channel with built-in telemetry - SPMSR3300T  
 SR3500 - 3-channel Micro Race - SPM1210

**Note:** The SR3000HRS (SPM1202) receiver is designed to be used with Spektrum's Futaba HRS compatible module system only and is not compatible with the DX3.0.

**DSM2:** SR3100 - 3-channel Pro - SPMSR3100  
 SR3520 - 3-channel Micro Pro - SPMSR3520



**Marine:** MR3000 - 3-channel Marine - SPMMR3000



Please note that DSM2 and marine compatible transmitters can be identified by the following logo located on the back of the transmitter:



**Note:** When using a separate NiMH receiver as a power source, the operating voltage range is 4.8–6.0V (4–5 cells) under load.

**Attention:** Make sure the male and female connectors have the correct polarity (+/-) before connecting. Be sure to orient the servo plug correctly for proper insertion.

Most electronic speed controllers are set up for BEC (Battery Elimination Circuitry) operation and plug directly into your receiver. See Figure A for a typical setup and check your speed controller's manual for correct installation.

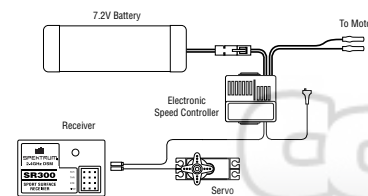

**Figure A** – Connections to BEC and receiver with electronic speed controller. NiMH battery speed controller and servos are not included in the radio set.

## Charging Jack

Located on the left-hand side of the transmitter is the charging jack, which accepts only JR® or Spektrum™ style wall chargers. Please do not attempt to use any other brand of wall charger as it may be the reverse polarity and can cause damage to your system. Only use the JR or Spektrum type wall charger when the DX3.0 is equipped with NiMH batteries.

**Warning:** Charge only rechargeable batteries. Non-rechargeable batteries may burst causing injury to persons and/or damage to property.

### Charger Pigtail For Transmitter

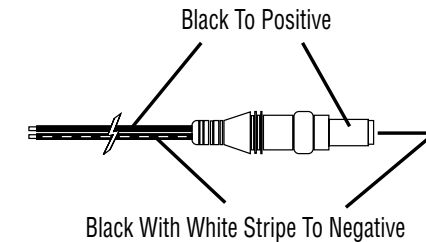

### Spektrum Transmitter Charge Jack Polarity



## Key Input and Display

Key	Use
SCROLL	Used to move up through the available functions
CHANNEL	Used to select the desired channel
INCREASE	Used to increase the value of the selected function
DECREASE	Used to decrease the value of the selected function

To enter the System Mode press the **SCROLL** and **CHANNEL** keys simultaneously and hold while turning on the transmitter.

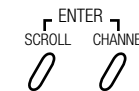

To enter the Function Mode, press the **SCROLL** key while the transmitter is on.

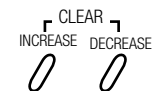

Press the **INCREASE** and **DECREASE** keys simultaneously to clear the screen or return to factory preset settings.

## Receiver Connections and Installation



## Display Screens

### Normal Display Screen

When the power switch is turned on, the LCD screen will read as shown below. This screen is referred to as the Normal Display.

**Note:** If any of the electronic trim buttons are moved while in this screen, the screen will automatically change to display the trim in use. This is called the Direct Trim Mode. For more information on the feature, please see page 5 of this manual.

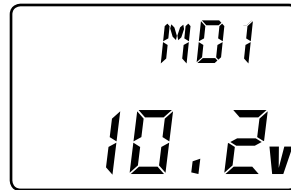

### Low Battery Screen/Lithium Battery Backup

When the voltage of the eight AA batteries drops below 9.0 volts, the DX3.0's display screen will alternate between the Normal (see above) and Low Battery screen (BAT). A beeping will occur, indicating that the batteries need to be replaced or recharged before further use.

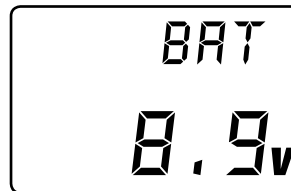

### Lithium Battery

Your DX3.0 radio system is equipped with a five-year lithium battery backup system. This system is designed to protect and retain all radio programming in the event that the transmitter batteries drop below the required 9.0 volts, or the transmitter battery case is removed during battery changes. If after five years it becomes necessary to replace the lithium battery, return your system to the Horizon Service Center for repair (see address, page 34–36).

### Memory Backup Screen

If the Memory Backup screen appears, this indicates the possibility of a memory issue or the lithium battery is dead. If you switch the power off and on again, and the transmitter is in default mode with all data lost, it is suggested that the DX3.0 transmitter be returned to the Horizon Service Center for servicing (see Warranty Information, page 34–36).



## Accessing the System Mode

To enter the System Mode, press both the **SCROLL** and **CHANNEL** keys at the same time while turning on the transmitter power switch. By pressing the **SCROLL** key, you can now choose Model Select, Model Name Input, Auxiliary Channel 3, Grip Button C function, Data Reset or the Model Copy function as shown here on the System Mode flow chart. Information for each function is located on the page number listed next to the function name on the flow chart.

To exit the System Mode, press the **SCROLL** and **CHANNEL** keys at the same time, or simply turn off the transmitter.

**Note:** If you turn the transmitter off and immediately enter System mode again, you will be returned to the last System mode function used instead of the Model Select function. While in System mode, there is no RF output generated by the transmitter. Adjustments can be performed with reduced battery power consumption. If you exit System mode by pressing the **SCROLL** and **CHANNEL** keys at the same time, RF output will not be enabled until you first turn off the transmitter.

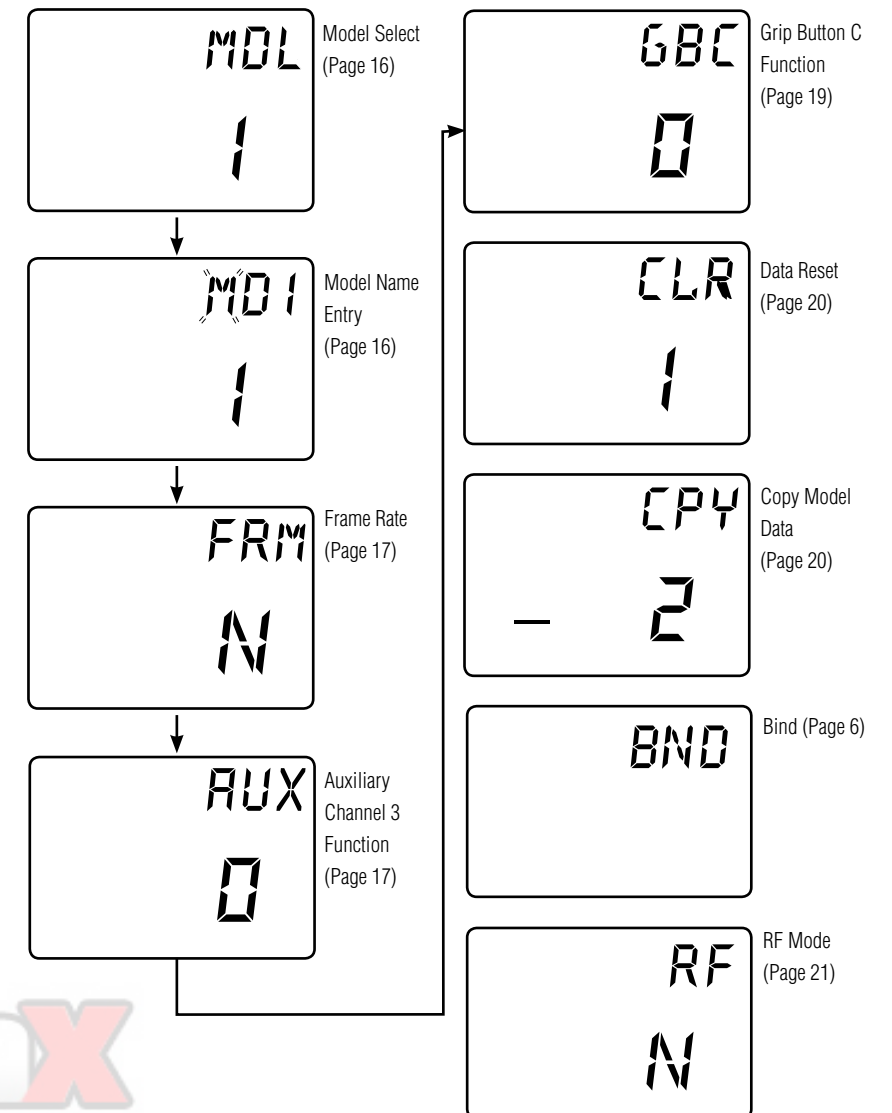



## Model Select System Mode

The DX3.0 has memory for four models. This feature allows for four different models to be operated with the same transmitter (additional receivers and servos must be purchased separately) or one model with four different race setups.

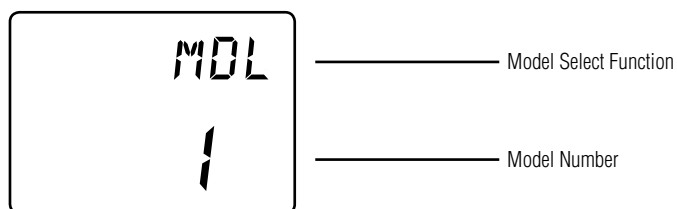

### Accessing the Model Select Function

1. Press the **SCROLL** and **CHANNEL** keys at the same time and hold.
2. Turn the transmitter power switch on to enter System Mode.
3. If "MDL" does not appear on the screen, press the SCROLL key until MDL appears.
4. Press the **INCREASE** or **DECREASE** key to select the desired model number (1, 2, 3, or 4).
5. Press the **SCROLL** key to access the Model Name Entry function.
6. To exit System Mode, either turn the transmitter power switch off or press the **SCROLL** and **CHANNEL** keys at the same time.

## Model Name Entry System Mode

The DX3.0 allows a three-character name to be input for each of the four models available. The current model, with name, will then be displayed in the Normal display screen. This feature is useful to help identify different models, setups, etc. For information on selecting models 1, 2, 3 or 4, please refer to the Model Select function above.

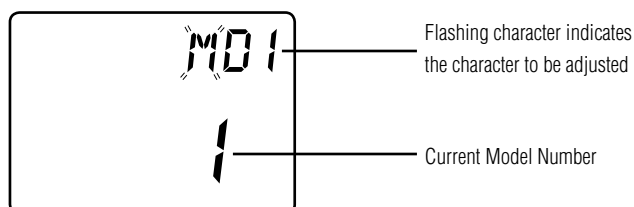

### Accessing the Model Name Entry Function

1. Press the **SCROLL** and **CHANNEL** keys at the same time and hold.
2. Turn on the transmitter power switch to enter the System Mode.
3. Press the **SCROLL** key until MD1 appears on the screen.
4. Press the **INCREASE** or **DECREASE** key to select the correct letter/number for the first character (flashing).
5. To change the remaining two characters, press the **CHANNEL** key until the desired character to be changed is flashing.
6. Press the **SCROLL** key to access the Frame Rate function.
7. To exit the System Mode, either turn the transmitter power switch off or press the **SCROLL** and **CHANNEL** keys at the same time.

## Frame Rate System Mode

Two frame rates are available: F and N.

F = Fast (11ms)  
N = Normal (16.5ms)

While most servos are compatible with the fast frame rate, some older analog servos require the use of the slower normal frame rate.

### Accessing the Frame Rate Function

1. Press the **SCROLL** and **CHANNEL** keys at the same time and hold.
2. Turn on the transmitter power switch to enter the System Mode.
3. Press the **SCROLL** key until FRM appears on the screen.
4. Press the **INCREASE** or **DECREASE** key to select the desired frame rate (N or F).
5. Press the **SCROLL** key to access the Auxiliary Channel 3 function.
6. To exit the System Mode, either turn the transmitter power switch off or press the **SCROLL** and **CHANNEL** keys at the same time.

## Auxiliary Channel 3 Function Select System Mode

The Auxiliary Channel 3 function of the DX3.0 allows you to select from two different types of Channel 3 servo travel movements, or to inhibit the Auxiliary Channel 3 function. Use the information below to select the correct Auxiliary Channel 3 function type for your particular installation. It is suggested the 0 function (factory preset) be selected for most applications.

**LN** = The LN, or linear, servo travel function is designed to be used when an engine fuel mixture servo is required. This function is most commonly used with gas-powered RC racing boats and is accessible through the Grip Lever A. In this function, the maximum travel of the servo is determined by the Endpoint Adjust function, page 24. The servo neutral position can be altered proportionately via the Grip Lever A for fuel mixture adjustment. When activated, fuel mixture trim values are visible for the Direct Trim function, page 28.

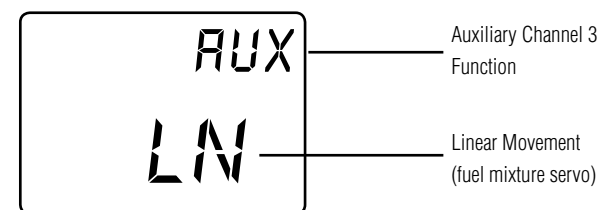

**2P** = The 2P, or 2 position, Servo Travel function is designed to be used as a transmission gear shift channel. This feature is designed for use only with vehicles such as the Traxxas T-Maxx. This function is accessible through the Grip Button C or Grip Lever A if Grip Button C is occupied by another function. The left and right travel values are determined by the Endpoint Adjustment function, page 24.

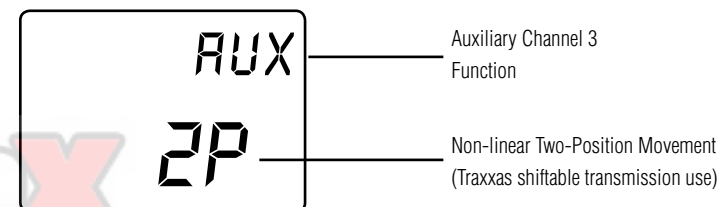

## Auxiliary Channel 3 Function Select System Mode (continued)

0 = The 0 or Inhibit function allows the Brake Endpoint Adjustment function, page 32, to be used. This function is designed to be used with most types of electric and gas-powered RC cars. This feature is extremely popular, as it allows the amount of panic braking accessible through the throttle trigger's braking position to be adjusted during operation for maximum effectiveness. When activated, the braking valves will be visible via the Direct Trim function, page 28.

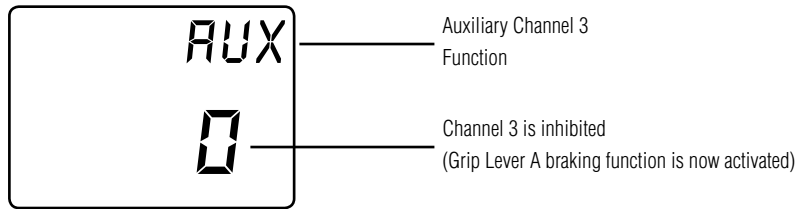

### Accessing the Auxiliary Channel 3 Function

LN = Linear servo movement  
 2P = 2-position servo movement  
 0 = Inhibited (Grip Lever A Braking is now activated)

1. Press the **SCROLL** and **CHANNEL** keys at the same time and hold.
2. Turn on the transmitter power switch to enter the System Mode.
3. Press the **SCROLL** key until AUX appears on the screen.
4. Press the **INCREASE** or **DECREASE** key to select the correct Auxiliary Channel 3 function type to be used.
5. Press the **SCROLL** key to access the Grip Button C Select function.
6. To exit the System mode, either turn the transmitter power switch off or press the **SCROLL** and **CHANNEL** keys at the same time.

## Grip Button C Function Select System Mode

The Grip Button C function of the DX3.0 allows you to select from three different functions available. Use the information below to select the correct Grip Button C assignment for your particular installation.

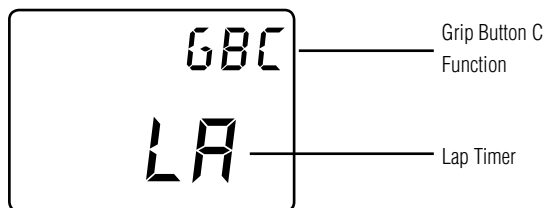

"0": Off. (Default) If "AUX" is "2P", then "2P" replaces "0" in this screen.  
 "Eb": ESB (Emergency Steering Button). To cancel the "STG" regulation for panic steering.  
 "LA": Lap Timer.

**Note:** If "LA" or "Eb" is selected and "2P" is assigned to the Auxiliary Channel 3 function, the Auxiliary Channel 3 function is moved to Grip Lever A (factory preset).

## Grip Button C Function Select System Mode (continued)

2P = The 0 or off function is the default setting and does not assign a function to Grip Button C. If the Auxiliary Channel 3 function is set to "2P" or 2-position, "2P" will appear in this screen in place of "0" and Grip Button C will function as the gear select button.

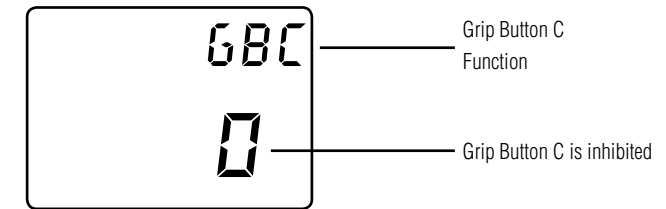

Eb = The Eb or Emergency Steering Button function is designed to momentarily override the value of Grip Lever B and provide 100% steering rate. This feature is useful if you have reduced the steering rate to make your vehicle easier to drive but need full steering in an emergency situation such as a collision. The override occurs only while the Grip Button C is depressed.

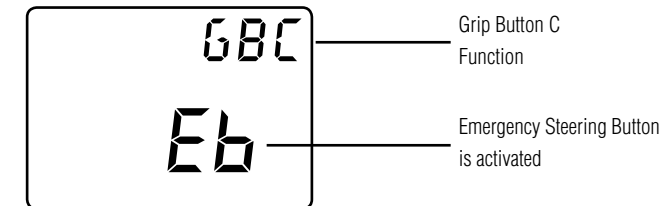

LA = The LA or Lap Timer function is designed to be used when you want to enable the recording of individual lap time. The Lap Timer function is described on page 26.

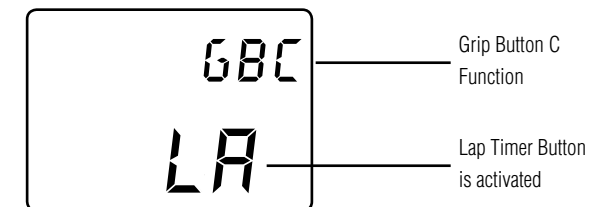

1. Press the **SCROLL** and **CHANNEL** keys at the same time and hold.
2. Turn on the transmitter power switch to enter System Mode.
3. Press the **SCROLL** key until GBC appears on the screen.
4. Press the **INCREASE** or **DECREASE** key to select the correct Grip Button C function type to be used.
5. Press the **SCROLL** key to access the Data Reset function.
6. To exit System mode, either turn the transmitter power switch off or press the **SCROLL** and **CHANNEL** keys at the same time.

## Data Reset System Mode

The Data Reset function allows you to reset all the programming in the selected model (1, 2, 3 or 4) to the factory default settings and to copy model data from one model memory to another. Before using the Data Reset function, it's important to enter the Model Select function and check to make sure the current model number indicated (1, 2, 3 or 4) is the model which you want to reset to the factory default settings. The Model Select function is described on page 16.

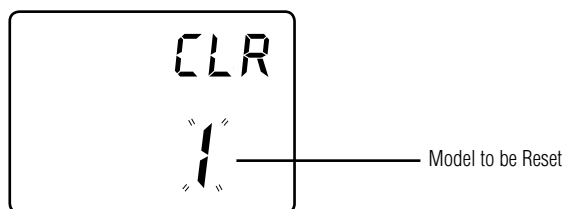

### Accessing the Data Reset Function

1. Press the **SCROLL** and **CHANNEL** keys at the same time and hold.
2. Turn on the transmitter power switch to enter the System Mode.
3. Press the **SCROLL** key until CLR appears on the screen.
4. Press the **INCREASE** or **DECREASE** key at the same time to reset the data. To confirm that the selected model's programming has been reset, a beep will sound and the model number selected (1, 2, 3 or 4) will stop flashing.
5. Press the **SCROLL** key to access the Copy Model Data function.
6. To exit the System mode, either turn the transmitter power switch off or press the **SCROLL** and **CHANNEL** keys at the same time.

## Copy Model Data System Mode

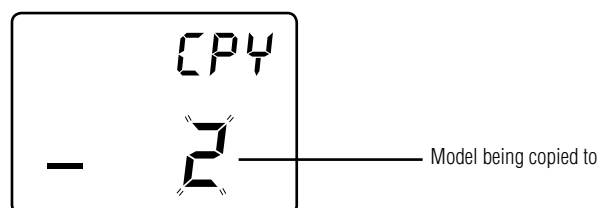

### Accessing the Copy Model Data Function

1. Press the **SCROLL** and **CHANNEL** keys at the same time and hold.
2. Turn on the transmitter power switch to enter the System Mode.
3. Press the **SCROLL** key until CPY appears on the screen.
4. Press the **INCREASE** or **DECREASE** key to select the desired model number you want the current model data copied to. The selected model number should be flashing.
5. Press the **INCREASE** and **DECREASE** keys at the same time to copy the current model data into the selected model number. To confirm that the selected model has been copied to, a beep will sound and the model number selected (1, 2, 3 or 4) will stop flashing.
6. To exit the System mode, either turn the transmitter power switch off or press the **SCROLL** and **CHANNEL** keys at the same time.

## RF Mode

The DX3.0 features a selectable RF mode. N is the standard RF mode. FR is the France RF mode and should only be selected if the transmitter is used in France.

### Accessing the RF Mode Function

To access the RF Mode function, follow the steps below:

1. Press the **SCROLL** and **CHANNEL** keys at the same time and hold.
2. Turn on the transmitter power switch to enter the System Mode.
3. Press the **SCROLL** key until RF appears on the screen.
4. Press the **INCREASE** and **DECREASE** keys to select the desired RF mode.
5. To exit the System Mode, either turn the transmitter power switch off or press the **SCROLL** and **CHANNEL** keys at the same time.



## Accessing the Function Mode

To enter the Function Mode, turn on the transmitter and then press the **SCROLL** key. The display will change to show the first function listed on the Function Mode flow chart as shown below. Press the **SCROLL** key to scroll down through the functions one by one, as shown in the flow chart. Once the desired function has been reached, use the **CHANNEL** key to select the appropriate channel (if applicable). To adjust the values of the function, simply press the **INCREASE (+)** or **DECREASE (-)** keys until the desired value is displayed on the screen. To exit function mode, press the **SCROLL** and **CHANNEL** keys at the same time. The next time you enter Function mode, you will be returned to the last function accessed.

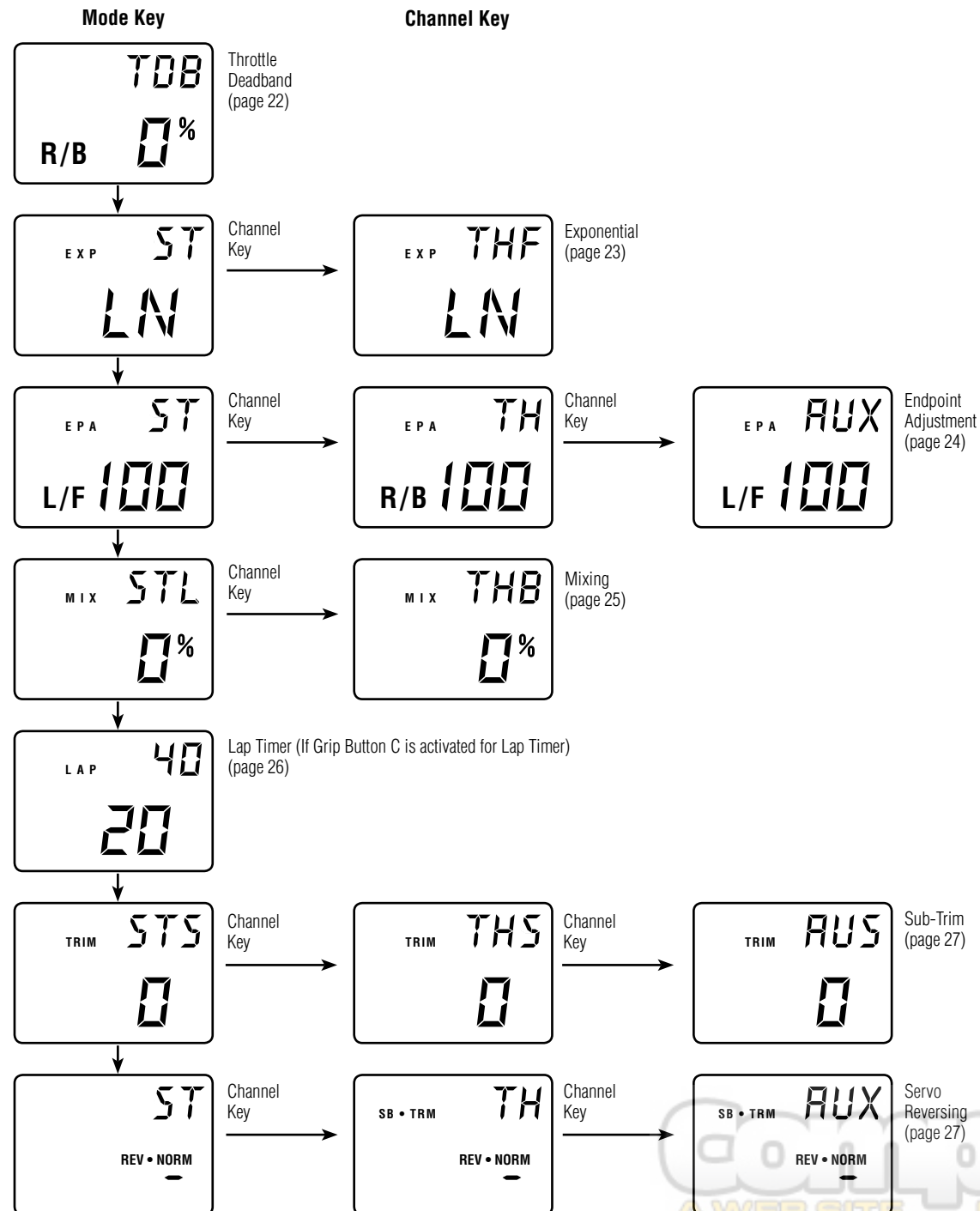

## Throttle Deadband Function Mode

The throttle deadband feature is used to reduce/eliminate the dead throttle area that exists at neutral to the starting point of throttle and from neutral to the starting point of braking. This area is sometimes known as deadband. As more throttle trim (also known as static brake) is applied, more of the dead trigger area right off neutral exists. To eliminate the throttle deadband, adjust a forward value such that your vehicle's wheels just start to turn when the trigger is slightly squeezed. This provides the most accurate feel and eliminates the dead area in the throttle. To eliminate the braking deadband, adjust the brake value such that your vehicle starts to slow down when the trigger is slightly pushed. This provides the most accurate brake feel and eliminates the dead area when braking.

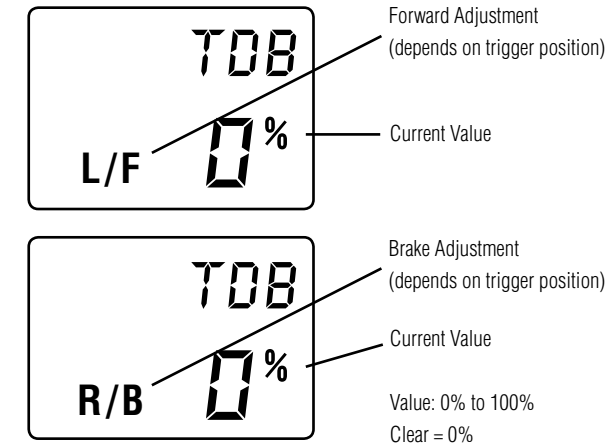

## Accessing the Throttle Deadband Function

1. Turn the transmitter power switch on.
2. Press the **SCROLL** key to access Function mode.
3. Press the **SCROLL** key until TDB appears on the screen.
4. Move the trigger accordingly to adjust the forward or braking deadband.
5. Press the **INCREASE** or **DECREASE** key to select the desired value necessary to eliminate dead area.
6. Press the **SCROLL** key to access Exponential mode.
7. To exit the Function mode, either turn the transmitter power switch off or press the **SCROLL** and **CHANNEL** keys at the same time.

## Exponential Function Mode

The Exponential feature of the DX3.0 allows you to alter the response rate of the steering or throttle control around neutral without affecting the maximum amount of steering or throttle available. The adjustment range is from -100% to 0% (Linear) to +100%. Exponential is factory-set to linear for both steering and throttle. Exponential is often used to settle down a car that is twitchy around center without giving up maximum steering response. The DX3.0 provides both positive (increase sensitivity at neutral) and negative (decrease sensitivity at neutral) exponential values.

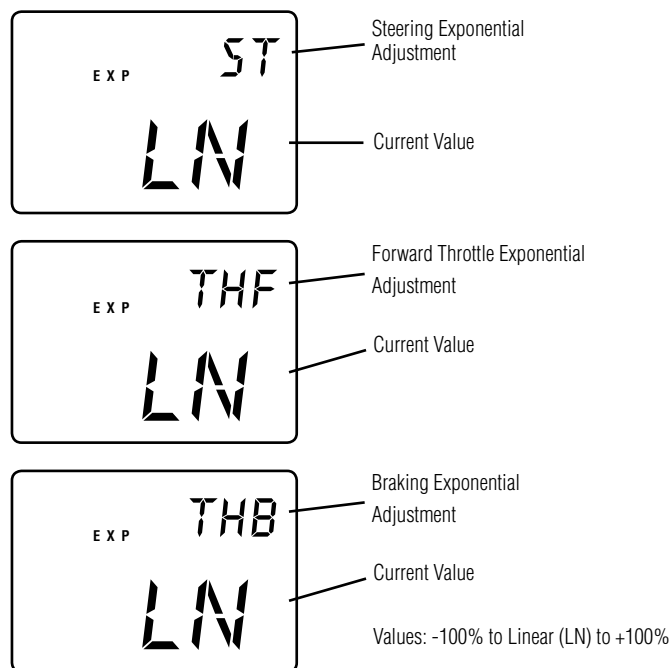

### Accessing the Exponential Function

1. Turn the transmitter power switch on.
2. Press the **SCROLL** key to access Function mode.
3. Press the **SCROLL** key until EXP appears on the screen.
4. Press the **INCREASE** or **DECREASE** key to select the desired exponential value.
5. Press the **SCROLL** key to access the travel Endpoint Adjustment function.
6. To exit the Function mode, either turn the transmitter power switch off or press the **SCROLL** and **CHANNEL** keys at the same time.

## Endpoint Adjustment Function Mode

The Endpoint Adjustment feature of the DX3.0 allows the maximum travel for the steering, throttle and Auxiliary Channel 3 (optional) servos to be increased or decreased in each direction to achieve the exact servo movement needed. The Endpoint Adjustment range is from 0% to 125% and is factory-set to 100% for all three channels. The value displayed on the screen depends on the current position of the steering wheel, trigger, or trim lever to be adjusted. This feature is very useful either to maximize servo travel or to reduce servo over-travel to eliminate servo binding (servos move further than the control mechanism allows), without the need for mechanical linkage adjustment.

The screens below are accessed by turning the wheel to the desired direction to be adjusted (left or right), by moving the trigger to the forward or backward (brake) position, or by toggling the Grip Button C.

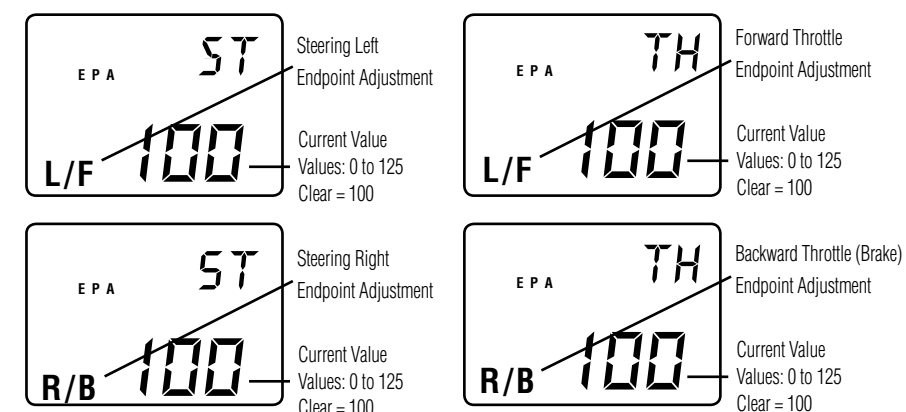

### Channel 3 Screens (optional)

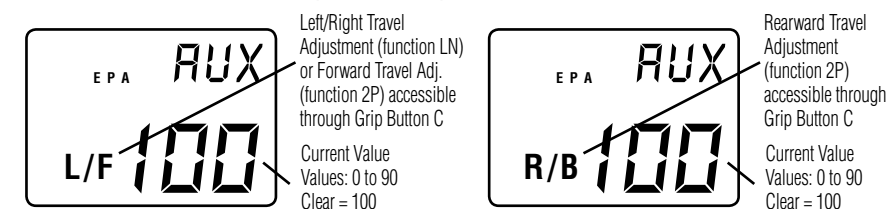

Functions LN & 2P

Functions 2P only

### Accessing the Endpoint Adjustment Function

1. Turn the transmitter power switch on.
2. Press the **SCROLL** key to access Function mode.
3. Press the **SCROLL** key until EPA appears on the left side of the screen.
4. Press the **CHANNEL** key to select the desired channel to be adjusted.
5. Move the steering wheel, trigger or Grip Button C in the desired direction for adjustment (left/right, forward/reverse or brake). Press the **INCREASE** or **DECREASE** key to achieve the desired amount of travel. Move the wheel, trigger or Grip Button C in the opposite direction to adjust travel in the opposite direction.
6. Press the **SCROLL** key to access the Mixing Adjustment function.
7. To exit the Function mode, either turn the transmitter power switch off or press the **SCROLL** and **CHANNEL** keys at the same time.

**Note:** When setting the Endpoint Adjustment values for the Steering function, it is suggested that, if possible, the maximum travel values be set to an equal value in both directions to maintain proper steering control.

## Programmable Mixing Function Mode

The DX3.0 offers two different mixing adjustments that allow for mixing one channel to another channel. The mixes available are Steering-to-Auxiliary Channel Mixing and Throttle-to-Auxiliary Channel Mixing. Each direction is independently adjustable. Popular use of this function includes 4-wheel steering and independent front and rear wheel brakes.

For example, Throttle-to-Auxiliary channel mixing can be used for independent front and rear wheel brakes. Each time the throttle/brakes are moved, the auxiliary channel will move in the direction and to the value input being given by the throttle channel. Mixing is proportional, so small inputs to the throttle will result in small output from the auxiliary channel. The adjustment range is from -125% to 0% to 125%. If the rate is negative, the channel is mixed in the opposite direction.

Both mixes share a single mixing "offset." The purpose of the mixing offset is to redefine the neutral position of the auxiliary channel, which can be set using Grip Lever A when "LN" is selected in the Auxiliary Channel 3 function. If the "LN" selection is turned off in the Auxiliary Channel 3 function with an offset value currently present, the value will continue to act as a mixing offset until the value is either cleared or changed. If a mix is not required, it is strongly suggested the mixing rate be set for 0%, which is the default.

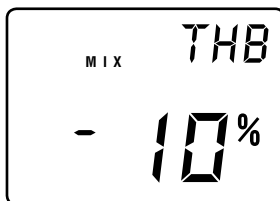
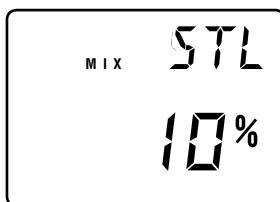

### Accessing the Mixing Adjustment Function

1. Turn the transmitter power switch on.
2. Press the **SCROLL** key to access Function mode.
3. Press the **SCROLL** key until MIX appears in the screen.
4. Press the **CHANNEL** key to select the desired mix to be used.
5. Move the steering wheel or trigger in the desired direction for adjustment (left/right, forward/reverse or brake). Press the **INCREASE** or **DECREASE** key to achieve the desired amount of mixing. Move the wheel or trigger in the opposite direction to adjust the mixing in the opposite direction.

**Note:** For Auxiliary Channel 3 function, if LN is selected, only L/F is adjustable.

6. Press the **SCROLL** key to access the Lap Timer (if enabled) or Sub-Trim function.
7. To exit the Function mode, either turn the transmitter power switch off or press the **SCROLL** and **CHANNEL** keys at the same time.

## Lap Timer Function Mode

The Lap Timer function of the DX3.0 allows the recording of individual lap times based on a 999 second up-timer. Up to 50 laps and times from 3.0 to 99.9 seconds can be stored in memory for review at a later time. The Lap Timer function will only be enabled and shown in Function mode if Grip Button C (System Mode) is set to "LA." With the Lap Timer enabled, pressing the channel key will alternate between the Normal display screen and Up-Timer display screen.

The Lap Timer is started by pressing Grip Button C. Once active, as shown by the blinking word "LAP," pressing Grip Button C again will begin recording the time of the next lap.

Note: A 3.0-second lap is the quickest lap allowed. This prevents accidental double pushing of Grip Button C when recording lap times. If more than 50 laps are recorded, each new lap will overwrite the oldest lap held in memory.

To stop the Lap Timer, press the Increase and Decrease keys at the same time. To restart the Lap Timer, press Grip Button C. To reset the Up-Timer, press the Channel key to show the Up-Timer display screen. With the Up-Timer stopped, press the Increase and Decrease keys at the same time to reset.

To review or reset lap times you must be in the Lap Timer function mode screen. Upon entering this function, the screen will always show the last lap time recorded. Use the Increase or Decrease keys to view the desired lap(s).

**Note:** If a recorded lap time is greater than 99.9 seconds, "OVR" will be displayed. To clear all lap times, press the Increase and Decrease keys at the same time.

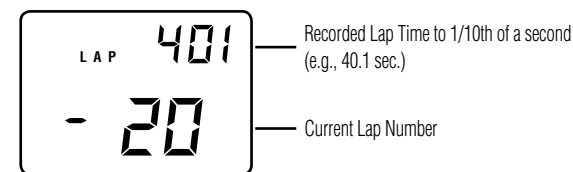

### Accessing the Lap Timer Function

1. Turn the transmitter power switch on.
2. Press the **SCROLL** key to access Function mode.
3. Press the **SCROLL** key until LAP appears in the screen.
4. Press the **INCREASE** or **DECREASE** key to view the desired lap time(s).
5. To reset all lap times, press the **INCREASE** and **DECREASE** keys at the same time.
6. Press the **SCROLL** key to access the Sub-Trim function.
7. To exit the Function mode, either turn the transmitter power switch off or press the **SCROLL** and **CHANNEL** keys at the same time.

## Sub-Trim Function Mode

The Sub-Trim function of the DX3.0 is an electronic trimming feature that allows the neutral position of the servo on either the steering, throttle or auxiliary channel (optional) to be moved, while allowing the electronic trim lever for that channel to remain in the center position. This feature is very useful as it allows the servo arm/wheel position to be moved to help with control linkage installation, eliminating the need to make mechanical linkage adjustments.

Although the Sub-Trim function is a very useful feature, it is suggested that only small amounts of Sub-Trim be used so that no unwanted, non-equal servo travel is created. It is suggested that less than 30 points of Sub-Trim be used during adjustment. If more than 30 points of Sub-Trim are required, it is suggested that a mechanical linkage adjustment be performed.

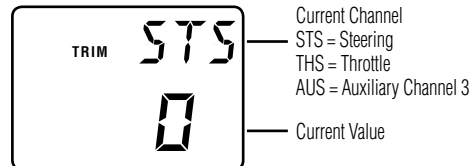

Values: R/B 125 ↔ 0 ↔ R/F 125

### Accessing the Sub-Trim Function

1. Turn the transmitter power switch on.
2. Press the **SCROLL** key to access Function mode.
3. Press the **SCROLL** key until TRIM appears in the screen.
4. Press the **CHANNEL** key to select the desired channel to be adjusted (Steering, Throttle or Auxiliary Channel 3).
5. Press the **INCREASE** or **DECREASE** key until the proper servo position is achieved.
6. Press the **SCROLL** key to access the Servo Reversing function.
7. To exit the Function mode, either turn the transmitter power switch off or press the **SCROLL** and **CHANNEL** keys at the same time.

## Servo Reversing Function Mode

The Servo Reversing feature of the DX3.0 is a very convenient feature when setting up a new model. The purpose of the servo reversing function is to change the direction of the servo rotation in relation to the wheel/trigger movement. The Servo Reversing function is available for the steering, throttle and Auxiliary Channel 3.

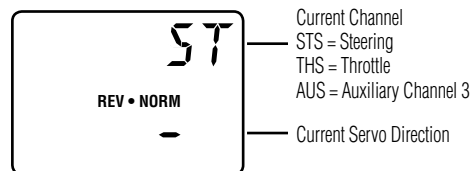

### Accessing the Servo Reversing Function

1. Turn the transmitter power switch on.
2. Press the **SCROLL** key to access Function mode.
3. Press the **SCROLL** key until REV • NORM appears in the screen.
4. Press the **CHANNEL** key to select the desired channel to be changed (Steering, Throttle or Auxiliary Channel 3).
5. Press the **INCREASE** or **DECREASE** key to move the cursor to the desired direction of travel.
6. To exit the Function mode, either turn the transmitter power switch off or press the **SCROLL** and **CHANNEL** keys at the same time.

## Accessing the Direct Trim Mode

The Direct Trim Mode function of the DX3.0 is accessible through the use of the electronic throttle or steering trim levers, as well as the two electronic grip levers (A&B) located on the upper portion of the grip handle. This function allows for quick trim adjustment of these controls.

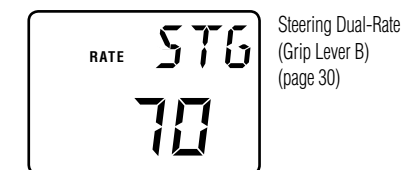
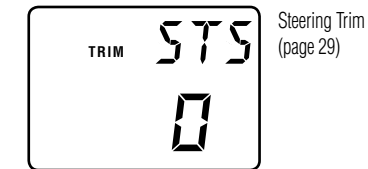

To access the Direct Trim Mode function, turn the transmitter power switch on. Next, move the desired trim lever to be adjusted. The appropriate screen for the selected trim lever will be displayed. To adjust, simply move the trim lever in the desired direction until the correct amount of trim is achieved. Once the desired trim is achieved, the screen will return to the Normal display screen after approximately two seconds from the last trim input. If the Increase or Decrease keys are pressed any time during the two seconds, the system will return to the previous screen in use.

Only present when Auxiliary function "0" is selected

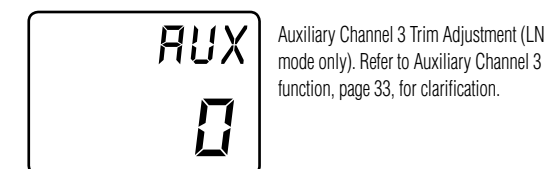
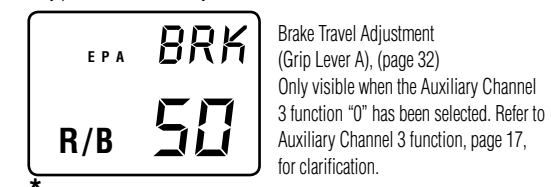

\*Note: When Auxiliary Channel 3 function 2P is selected, the two screens above are not present.

## Steering Trim (STC)

The DX3.0 electronic Steering Trim lever, located just above the steering wheel, allows the center position of the servo to be manipulated in either direction to achieve precise centering of the steering assembly. Steering Travel Endpoint Adjustment values (page 24) remain completely independent from the steering trim, unless the trim value exceeds the selected endpoint values. (For example: If trim value is set at 30 and endpoint values at 15, steering trim will override/alter the endpoint value.)

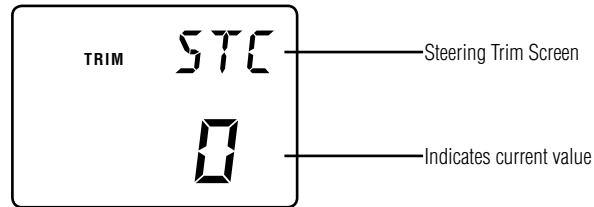

Values: L/F 30 ↔ 0 ↔ R/B 30

Each click will provide 0.3° of trim to the center of the steering servo with a maximum of 12° allowed.

**Note:** Each click will not always result in a change of the value displayed.

To adjust the steering trim servo position, move the electronic Steering Trim lever either to the left (+) or the right (-). As soon as the trim is moved, the STC Steering Trim screen will appear and will continue to be displayed unless the trim lever is untouched for a period of two seconds. To reset the trim value to 0, press the **INCREASE** and **DECREASE** keys at the same time while the "STC" screen is displayed.



## Throttle Trim (THC)

The DX3.0's electronic Throttle Trim lever, located to the left of the steering wheel, allows the center position of the servo to be manipulated in either direction to achieve precise centering of the throttle trigger neutral position. Throttle Endpoint adjustment values (page 24) remain completely independent from the throttle trim, unless the trim value exceeds the selected endpoint values. (For example: If the trim value is set at 40 and the endpoint values at 30, Throttle Trim will override/alter the endpoint value.)

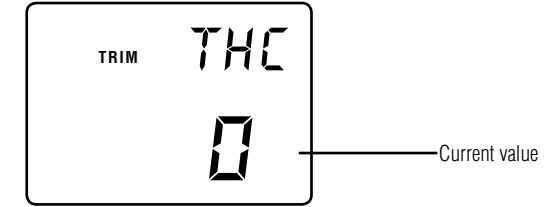

Values: L/F 60 ↔ 0 ↔ R/B 60

Each click will provide 0.3° of trim to the throttle servo with a maximum of 24° allowed.

**Note:** Each click will not always result in a change of the value displayed.

To adjust the Throttle Trim servo position, move the electronic steering trim lever either up (+) or down (-). As soon as the trim is moved, the THC Throttle Trim screen will appear and will continue to be displayed unless the trim lever is untouched for a period of two seconds. To reset the trim value to zero, press the **INCREASE** and **DECREASE** keys at the same time while the "THC" screen is displayed.

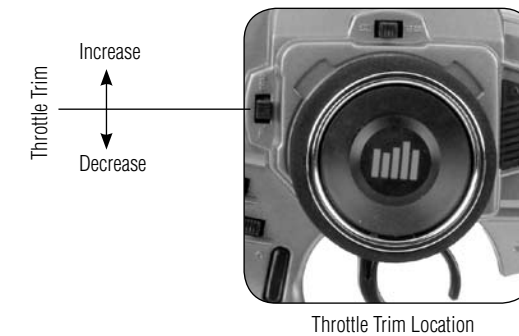



## Grip Lever B: Steering Dual Rate Trim Adjustment STG

The Steering Dual Rate Trim Adjustment, located at Grip Lever B, allows the dual rate value (maximum servo travel) to be increased or decreased within a range from 100% through 20% of the total endpoint value established in the steering EPA function. This function is very useful in race conditions as it allows you to custom tailor the steering radius and sensitivity for the current track conditions. Please note that since the Dual Rate value shown in the "STG" screen is the percentage of the endpoint value established in the steering EPA function, the value will not always increase or decrease each time the Grip Lever B is moved.

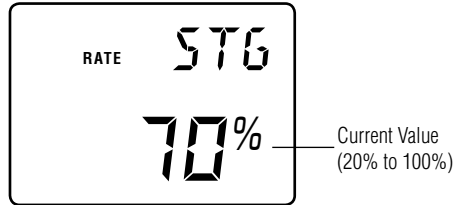

If the Emergency Steering button function (page 18) is active, pressing Grip Button C will restore the steering dual rate to 100% until the button is released.

To adjust the Steering Dual Rate value, move the electronic Grip Lever B either left (-) or right (+). As soon as the trim is moved, the STG Steering Dual Rate screen will appear and will continue to be displayed unless the Grip Lever B is untouched for a period of two seconds. To reset the trim value to the factory preset setting of 70%, press the INCREASE and DECREASE keys at the same time while the "STG" screen is displayed.

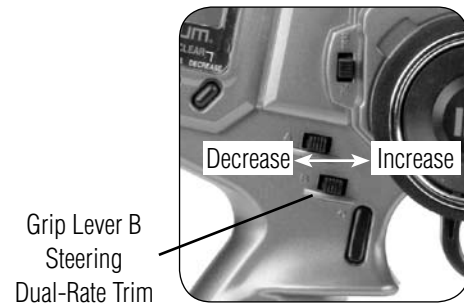

## Grip Lever A: Brake Endpoint Adjustment BRK/Auxiliary Channel 3 Access

The Brake Endpoint Adjustment, located at Grip Lever A, allows the maximum servo travel on the braking side of the throttle trigger to be increased or decreased from 100% to 0% (off). This function is very useful in race conditions as it allows the racer to custom tailor the "panic" brake value to maximize the car's braking power for the current track conditions. Please note that since the brake endpoint value shown in the BRK screen is a percentage of the total braking value established in the Endpoint Adjustment function (page 24), the value will not always increase or decrease each time the Grip Lever A is moved.

**Note:** If Grip Lever A is assigned an Auxiliary Channel 3 function by selecting "LN" or "2P" with Grip Button C in use, the Brake Endpoint Adjustment will not be available.

To adjust the brake endpoint value, move the electronic Grip Lever A either left (-) or right (+). As soon as the grip lever is moved, the BRK Endpoint Adjustment screen will appear and will continue to be displayed unless the Grip Lever A is untouched for a period of two seconds.

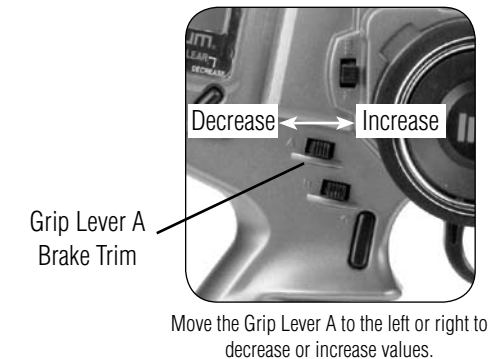
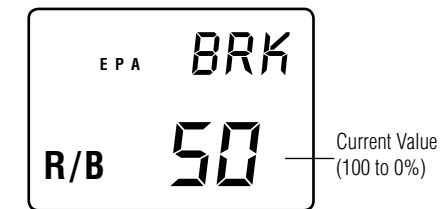

## Auxiliary Channel 3 Access (Fuel Mixture)

When selected, Grip Lever A can be used to access the Auxiliary Channel 3 function of the DX3.0 for use as a fuel mixture channel.

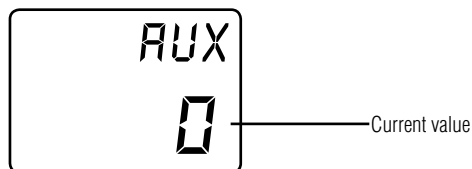

When the LN (linear) Auxiliary Channel 3 function is selected, Grip Lever A can be used to change the neutral position of the servo to lean or richen the engine's fuel mixture. Once the desired fuel mixture has been achieved, the Grip Lever A value indicated on this screen can be transferred manually to the Sub-Trim function (page 27) and the value of the AUX screen can be returned to zero. Please refer to the diagram below for proper grip lever operation.

## Auxiliary Channel 3 (Transmission Shift Selector)

When the 2P Auxiliary Channel function is selected, the Grip Lever A can be used to move the Auxiliary 3 Channel servo to one of two positions (left/right or forward/reverse) when LA or Eb is selected for the Grip Button C function. Please refer to diagram A below for proper shifting procedures.

**Note:** The Endpoint Adjustment function (page 24) is used to set the forward and reverse gear servo travel positions.

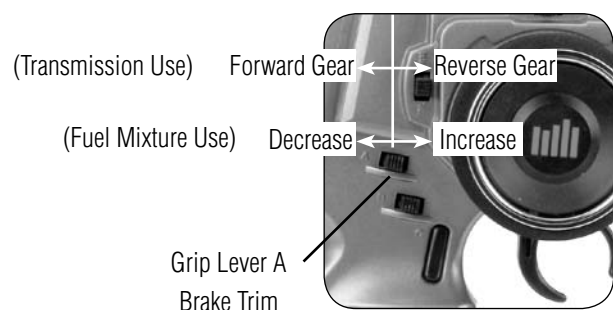

## Warranty and Service Information

### Warranty Period

Exclusive Warranty- Horizon Hobby, Inc., (Horizon) warrants that the Products purchased (the "Product") will be free from defects in materials and workmanship for a period of 1 year from the date of purchase by the Purchaser.

### Limited Warranty

(a) This warranty is limited to the original Purchaser ("Purchaser") and is not transferable. REPAIR OR REPLACEMENT AS PROVIDED UNDER THIS WARRANTY IS THE EXCLUSIVE REMEDY OF THE PURCHASER. This warranty covers only those Products purchased from an authorized Horizon dealer. Third party transactions are not covered by this warranty. Proof of purchase is required for warranty claims. Further, Horizon reserves the right to change or modify this warranty without notice and disclaims all other warranties, express or implied.

(b) Limitations- HORIZON MAKES NO WARRANTY OR REPRESENTATION, EXPRESS OR IMPLIED, ABOUT NON-INFRINGEMENT, MERCHANTABILITY OR FITNESS FOR A PARTICULAR PURPOSE OF THE PRODUCT. THE PURCHASER ACKNOWLEDGES THAT THEY ALONE HAVE DETERMINED THAT THE PRODUCT WILL SUITABLY MEET THE REQUIREMENTS OF THE PURCHASER'S INTENDED USE.

(c) Purchaser Remedy- Horizon's sole obligation hereunder shall be that Horizon will, at its option, (i) repair or (ii) replace, any Product determined by Horizon to be defective. In the event of a defect, these are the Purchaser's exclusive remedies. Horizon reserves the right to inspect any and all equipment involved in a warranty claim. Repair or replacement decisions are at the sole discretion of Horizon. This warranty does not cover cosmetic damage or damage due to acts of God, accident, misuse, abuse, negligence, commercial use, or modification of or to any part of the Product. This warranty does not cover damage due to improper installation, operation, maintenance, or attempted repair by anyone other than Horizon. Return of any goods by Purchaser must be approved in writing by Horizon before shipment.

### Damage Limits

HORIZON SHALL NOT BE LIABLE FOR SPECIAL, INDIRECT OR CONSEQUENTIAL DAMAGES, LOSS OF PROFITS OR PRODUCTION OR COMMERCIAL LOSS IN ANY WAY CONNECTED WITH THE PRODUCT, WHETHER SUCH CLAIM IS BASED IN CONTRACT, WARRANTY, NEGLIGENCE, OR STRICT LIABILITY. Further, in no event shall the liability of Horizon exceed the individual price of the Product on which liability is asserted. As Horizon has no control over use, setup, final assembly, modification or misuse, no liability shall be assumed nor accepted for any resulting damage or injury. By the act of use, setup or assembly, the user accepts all resulting liability.

If you as the Purchaser or user are not prepared to accept the liability associated with the use of this Product, you are advised to return this Product immediately in new and unused condition to the place of purchase.

Law: These Terms are governed by Illinois law (without regard to conflict of law principals).

### Safety Precautions:

This is a sophisticated hobby Product and not a toy. It must be operated with caution and common sense and requires some basic mechanical ability. Failure to operate this Product in a safe and responsible manner could result in injury

or damage to the Product or other property. This Product is not intended for use by children without direct adult supervision. The Product manual contains instructions for safety, operation and maintenance. It is essential to read and follow all the instructions and warnings in the manual, prior to assembly, setup or use, in order to operate correctly and avoid damage or injury.

#### **Questions, Assistance, and Repairs**

Your local hobby store and/or place of purchase cannot provide warranty support or repair. Once assembly, setup or use of the Product has been started, you must contact Horizon directly. This will enable Horizon to better answer your questions and service you in the event that you may need any assistance. For questions or assistance, please direct your email to [productsupport@horizonhobby.com](mailto:productsupport@horizonhobby.com), or call 877.504.0233 toll free to speak to the product support department.

#### **Inspection or Repairs**

If this Product needs to be inspected or repaired, please call for a Return Merchandise Authorization (RMA). Pack the Product securely using a shipping carton. Please note that original boxes may be included, but are not designed to withstand the rigors of shipping without additional protection. Ship via a carrier that provides tracking and insurance for lost or damaged parcels, as Horizon is not responsible for merchandise until it arrives and is accepted at our facility. A Service Repair Request is available at [www.horizonhobby.com](http://www.horizonhobby.com) on the "Support" tab. If you do not have internet access, please include a letter with your complete name, street address, email address and phone number where you can be reached during business days, your RMA number, a list of the included items, method of payment for any non-warranty expenses and a brief summary of the problem. Your original sales receipt must also be included for warranty consideration. Be sure your name, address, and RMA number are clearly written on the outside of the shipping carton.

#### **Warranty Inspection and Repairs**

To receive warranty service, you must include your original sales receipt verifying the proof-of-purchase date. Provided warranty conditions have been met, your Product will be repaired or replaced free of charge. Repair or replacement decisions are at the sole discretion of Horizon Hobby.

#### **Non-Warranty Repairs**

Should your repair not be covered by warranty the repair will be completed and payment will be required without notification or estimate of the expense unless the expense exceeds 50% of the retail purchase cost. By submitting the item for repair you are agreeing to payment of the repair without notification. Repair estimates are available upon request. You must include this request with your repair. Non-warranty repair estimates will be billed a minimum of ½ hour of labor. In addition you will be billed for return freight. Please advise us of your preferred method of payment. Horizon accepts money orders and cashiers checks, as well as Visa, MasterCard, American Express, and Discover cards. If you choose to pay by credit card, please include your credit card number and expiration date. Any repair left unpaid or unclaimed after 90 days will be considered abandoned and will be disposed of accordingly. Please note: non-warranty repair is only available on electronics and model engines.

#### **United States:**

Electronics and engines requiring inspection or repair should be shipped to the following address:

Horizon Service Center  
4105 Fieldstone Road  
Champaign, Illinois 61822 USA

All other Products requiring warranty inspection or repair should be shipped to the following address:

Horizon Product Support  
4105 Fieldstone Road  
Champaign, Illinois 61822 USA

Please call 877-504-0233 or e-mail us at [productsupport@horizonhobby.com](mailto:productsupport@horizonhobby.com) with any questions or concerns regarding this product or warranty.

#### **United Kingdom:**

Electronics and engines requiring inspection or repair should be shipped to the following address:

Horizon Hobby UK  
Units 1-4 Ployters Rd  
Staple Tye  
Harlow, Essex  
CM18 7NS  
United Kingdom

Please call +44 (0) 1279 641 097 or e-mail us at [sales@horizonhobby.co.uk](mailto:sales@horizonhobby.co.uk) with any questions or concerns regarding this product or warranty.

#### **Germany:**

Electronics and engines requiring inspection or repair should be shipped to the following address:

Horizon Technischer Service  
Hamburger Strasse 10  
25335 Elmshorn  
Germany

Please call +49 4121 46199 66 or e-mail us at [service@horizonhobby.de](mailto:service@horizonhobby.de) with any questions or concerns regarding this product or warranty.

## FCC Information

This device complies with part 15 of the FCC rules. Operation is subject to the following two conditions: (1) This device may not cause harmful interference, and (2) this device must accept any interference received, including interference that may cause undesired operation.

**Caution:** Changes or modifications not expressly approved by the party responsible for compliance could void the user's authority to operate the equipment.

This product contains a radio transmitter with wireless technology which has been tested and found to be compliant with the applicable regulations governing a radio transmitter in the 2.400GHz to 2.4835GHz frequency range.

### Antenna Separation Distance

When operating your Spektrum transmitter, please be sure to maintain a separation distance of at least 5 cm between your body (excluding fingers, hands, wrists, ankles and feet) and the antenna to meet RF exposure safety requirements as determined by FCC regulations.

The illustrations below show the approximate 5 cm RF exposure area and typical hand placement when operating your Spektrum transmitter.

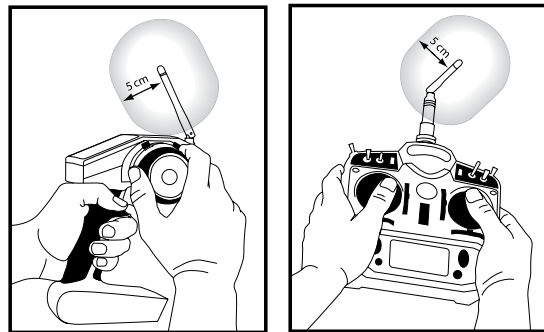

## CE Compliance Information for the European Union

The associated regulatory agencies of the following countries recognize the noted certifications for this product as authorized for sale and use.

UK	DE	DK	BG	SE	FI	EE	LV	LT
PL	CZ	SK	HU	RO	SI	AT	IT	ES
PT	IE	NL	LU	MT	CY	GR	FR	

## Instructions for Disposal of WEEE by Users in the European Union

This product must not be disposed of with other waste. Instead, it is the user's responsibility to dispose of their waste equipment by handing it over to a designated collection point for the recycling of waste electrical and electronic equipment. The separate collection and recycling of your waste equipment at the time of disposal will help to conserve natural resources and ensure that it is recycled in a manner that protects human health and the environment. For more information about where you can drop off your waste equipment for recycling, please contact your local city office, your household waste disposal service or where you purchased the product.

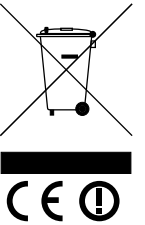

## Declaration of Conformity

(in accordance with ISO/IEC 17050-1)

No. HH2008111004

Product(s): Spektrum DX3.0 Transmitter  
Item Number(s): SPM20320E

Equipment class: 2

The objects of declaration described above are in conformity with the requirements of the specifications listed below, following the provisions of the European R&TTE directive 1999/5/EC:

**EN 300-328 v1.7.1** ERM requirements for wideband transmission systems operating in the 2.4 GHz ISM band

**EN 301 489-1 v.1.6.1** General EMC requirements for Radio equipment  
**EN 301 489-17 v.1.2.1**

Signed for and on behalf of:  
Horizon Hobby, Inc.  
Champaign, IL USA  
November 10, 2008

Steven A. Hall  
Vice President  
International Operations and Risk Management  
Horizon Hobby, Inc.

**CompetitionX**  
A WEB SITE FOR THE SERIOUS RAGER